



Cypress EZ-USB® FX3™ SDK

EZ-USB Suite User Guide

Version 1.3.3

Cypress Semiconductor
198 Champion Court
San Jose, CA 95134-1709
Phone (USA): 800.858.1810
Phone (Intl): 408.943.2600
<http://www.cypress.com>



Copyrights

Copyright © 2014 Cypress Semiconductor Corporation. All rights reserved.

EZ-USB, FX3, FX3S, CX3, FX2G2 and GPIF are trademarks of Cypress Semiconductor. All other trademarks or registered trademarks referenced herein are the property of their respective owners.

The information in this document is subject to change without notice and should not be construed as a commitment by Cypress. While reasonable precautions have been taken, Cypress assumes no responsibility for any errors that may appear in this document. No part of this document may be copied or reproduced in any form or by any means without the prior written consent of Cypress. Made in the U.S.A.

Disclaimer

CYPRESS MAKES NO WARRANTY OF ANY KIND, EXPRESS OR IMPLIED, WITH REGARD TO THIS MATERIAL, INCLUDING, BUT NOT LIMITED TO, THE IMPLIED WARRANTIES OF MERCHANTABILITY AND FITNESS FOR A PARTICULAR PURPOSE. Cypress reserves the right to make changes without further notice to the materials described herein. Cypress does not assume any liability arising out of the application or use of any product or circuit described herein. Cypress does not authorize its products for use as critical components in life-support systems where a malfunction or failure may reasonably be expected to result in significant injury to the user. The inclusion of Cypress' product in a life-support systems application implies that the manufacturer assumes all risk of such use and in doing so indemnifies Cypress against all charges.

License Agreement

Please read the license agreement during installation.

Contents



1	EZ-USB Suite	4
	1.1 Introduction	4
	1.2 IDE Features.....	4
2	Creating an FX3 Firmware Project	5
	2.1 Starting the EZ-USB Suite IDE	5
	2.2 Creating the Project	6
	2.3 Creating a New Project Based on Templates	11
3	JTAG Debugging of Firmware Projects	14
	3.1 Debugging using Segger J-Link	14
	3.2 Debugging with OpenOCD	21
4	CX3 Configuration Utility	26
	4.1 Introduction to the CX3 device	26
	4.2 CX3 MIPI CSI-2 interface	27
	4.3 Configuring the CX3 Device	30
	4.4 Using the CSI Configuration Utility	32
	4.5 GPIF-II interface on the CX3	44

1 EZ-USB Suite



1.1 Introduction

EZ-USB Suite is the integrated development environment provided by Cypress for firmware development and debugging using the EZ-USB FX3 and associated parts.

EZ-USB Suite is based on the standard Eclipse Kepler IDE for C/C++ Developers, and provides a few customizations that are FX3 device family specific.

1.2 IDE Features

The EZ-USB Suite IDE provides firmware development and debugging support for FX3 applications. It also provides a mechanism to create new FX3 firmware projects, and plug-ins for through which other FX3 applications such as Control Center and GPIF-II Designer can be accessed.

The IDE is integrated with the GNU ARM tool-chain for firmware compilation, linking and debugging. The ARM GNU Eclipse plug-in is used for managed builds and debugging.

The following chapters provide more detailed description on the IDE features.

2 Creating an FX3 Firmware Project



This chapter outlines the steps involved in creating a FX3 firmware application, using the GpifToUsb project from the SDK as a reference.

2.1 Starting the EZ-USB Suite IDE

Launch the EZ-USB Suite IDE by following the “All Programs -> Cypress -> Eclipse -> EZ USB Suite” path from the Start Menu.

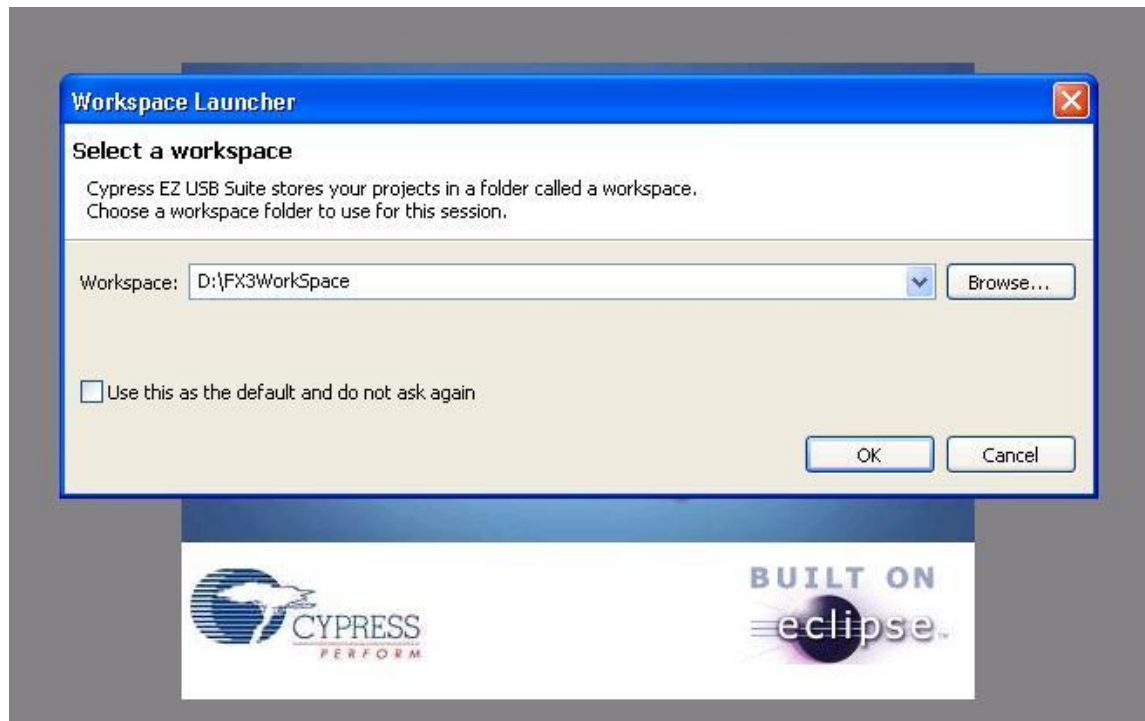

Figure 2-1: Workspace Selection Dialog

The IDE will prompt for a Workspace to be opened. If you have already created a workspace, select it from the dropdown box. Otherwise, provide the path where the new workspace has to be created and Click OK.

2.2 Creating the Project

The easiest way to create a new FX3 firmware project under the Eclipse IDE, is to import an existing project and make changes to it.

1. Choose the Import option under the File menu to bring up the Import options window. Choose “Existing Projects into Workspace” from the “General” group.

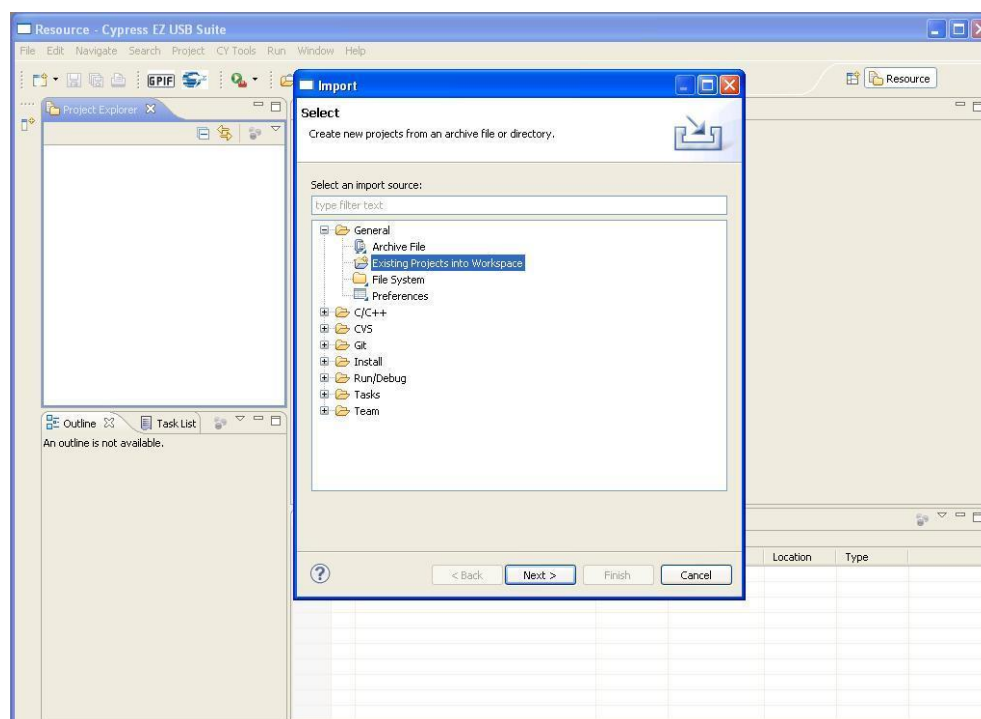

Figure 2-2: Project Import Dialog

2. In the “Browse for Folder” window that pops up, navigate into the firmware/basic_examples/cyfxgpiftousb folder in the FX3 SDK installation.

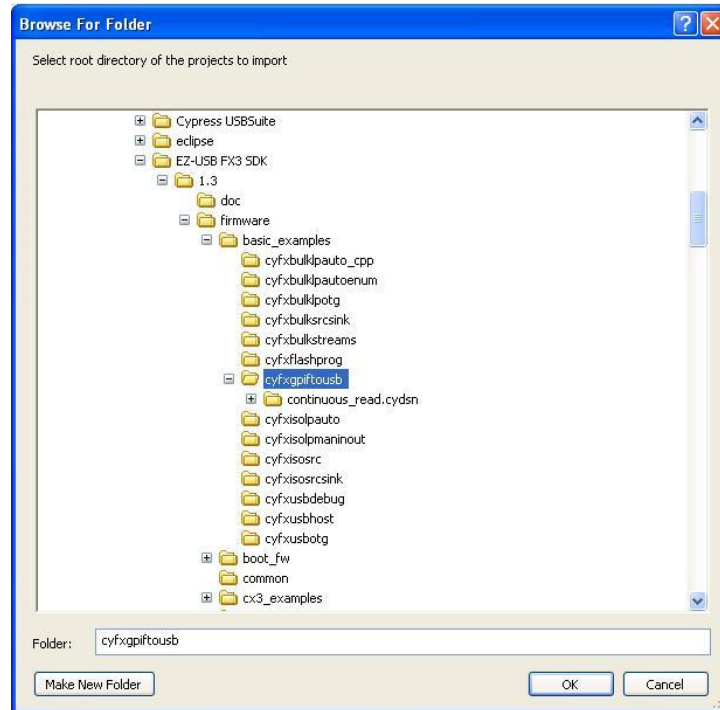

Figure 2-3: Folder Browse Dialog

3. Select the “Copy projects into workspace” option in the Import window, so that we get a new copy of the source files that can be modified.

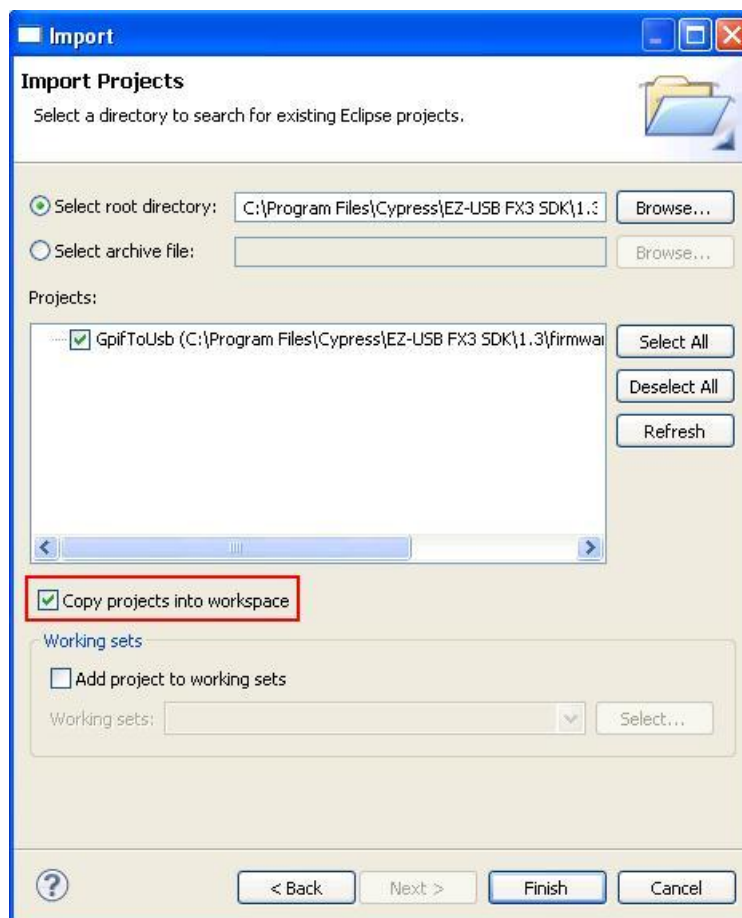

Figure 2-4: Import Projects Dialog

4. If desired, right-click the project name and use the “Rename” option to rename the project. The respective source files in the project can also be renamed as desired. If the header files are renamed, references to the header file in the source files will need to be updated.

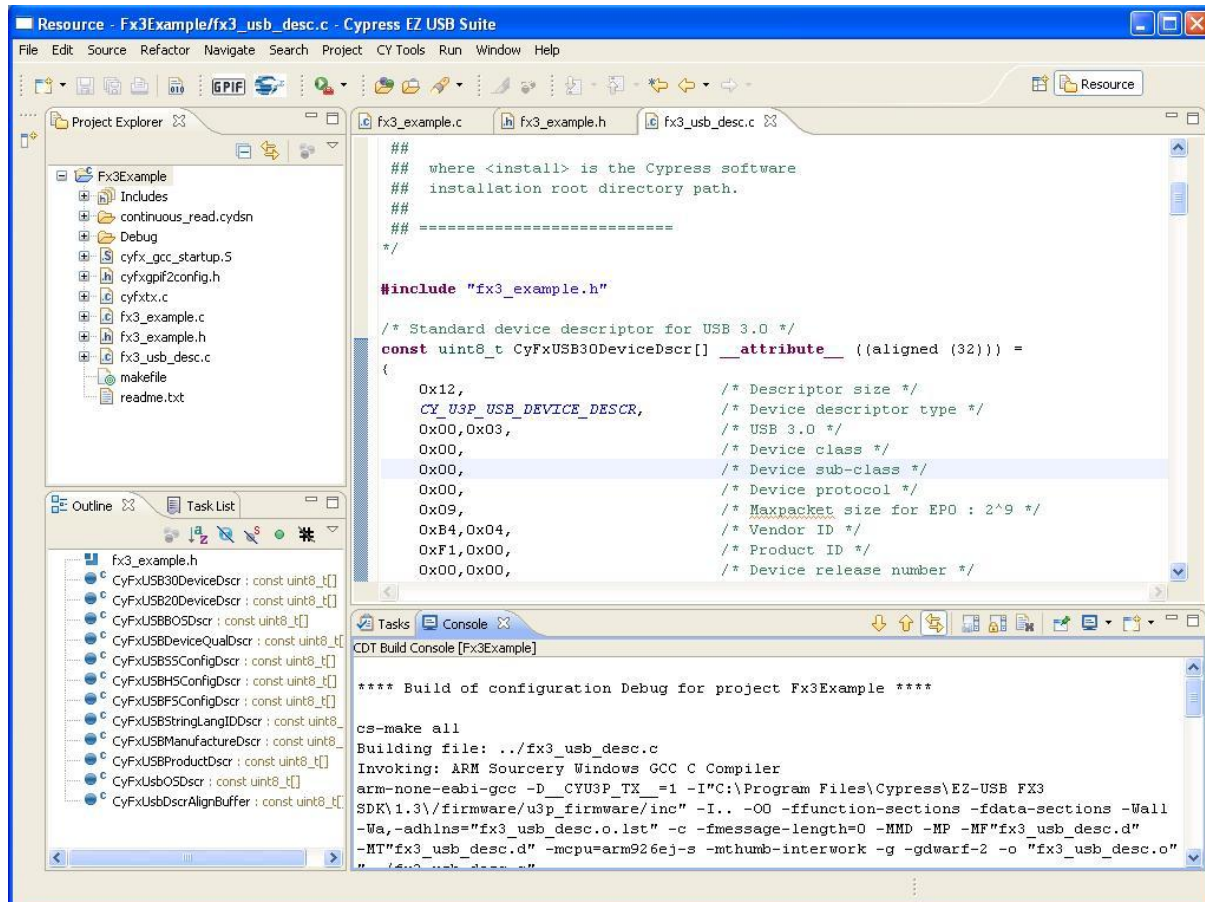

Figure 2-5: EZ USB Suite Eclipse Based IDE

5. Add additional source files as required. This can be done in one of two ways:
 - a. Right-click the project name and select the “New -> Header File” or “New -> Source File” option as appropriate.

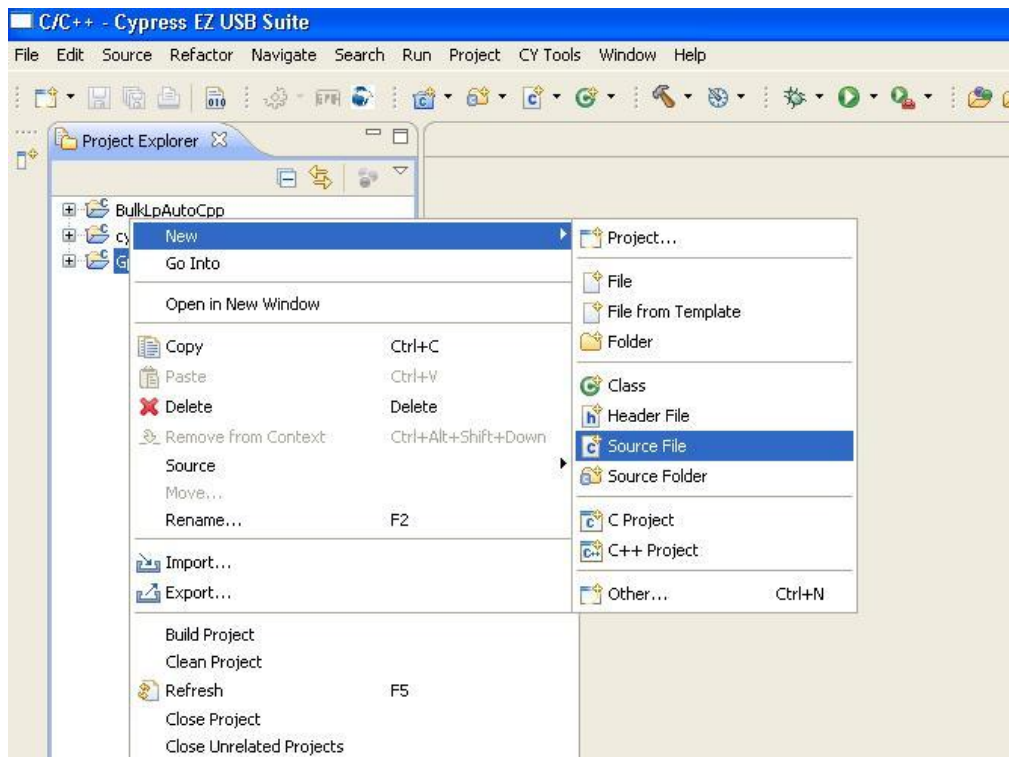

Figure 2-6: Adding new source files to a project

- b. Copy the file into the project folder inside the workspace and use the Refresh (F5 key) option to make it visible in the project.
6. The build settings for the project will already be functional. Right-Click on the project name and use the “Properties” menu item to view and modify the build settings.
7. Build the project to verify that the project import and renaming is successful.

2.3 Creating a New Project Based on Templates

Another way to create a new FX3 firmware project is to use the Create Project based on Templates option provided by EZ-USB Suite.

1. Select the New -> Project option from the File menu.

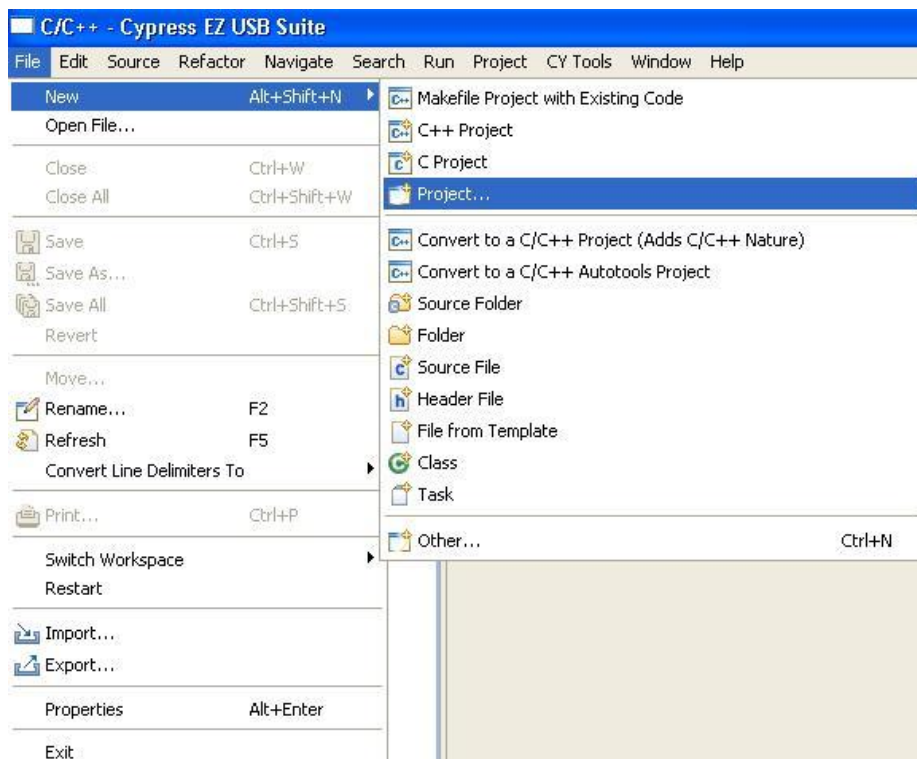

Figure 2-7: Selecting the New Project Menu Item

2. Choose the “Cypress -> FX3 Project” option from the resulting popup window and click on “Next”.

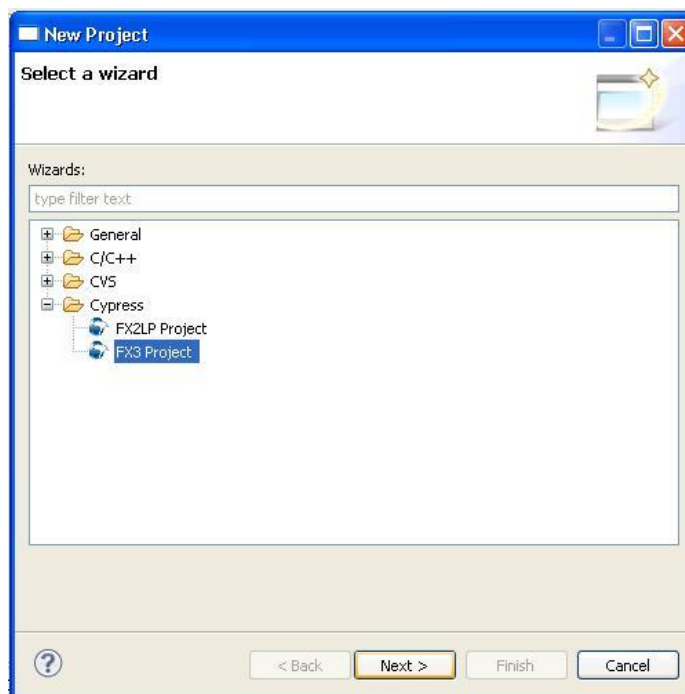

Figure 2-8: Choosing project type to be created

3. Three project templates are provided. The `cyfx3bootappgcc` template creates a project based on the FX3 boot library. The `cyfxbulksrsrcsink` template creates a project that does not include a GPIF-II configuration. The `slfifoasync` template creates a project that includes a GPIF-II configuration. Select the “Create the Project using one of the Templates” checkbox, select the desired template, provide a name for the project; and click “Finish” to create the project.

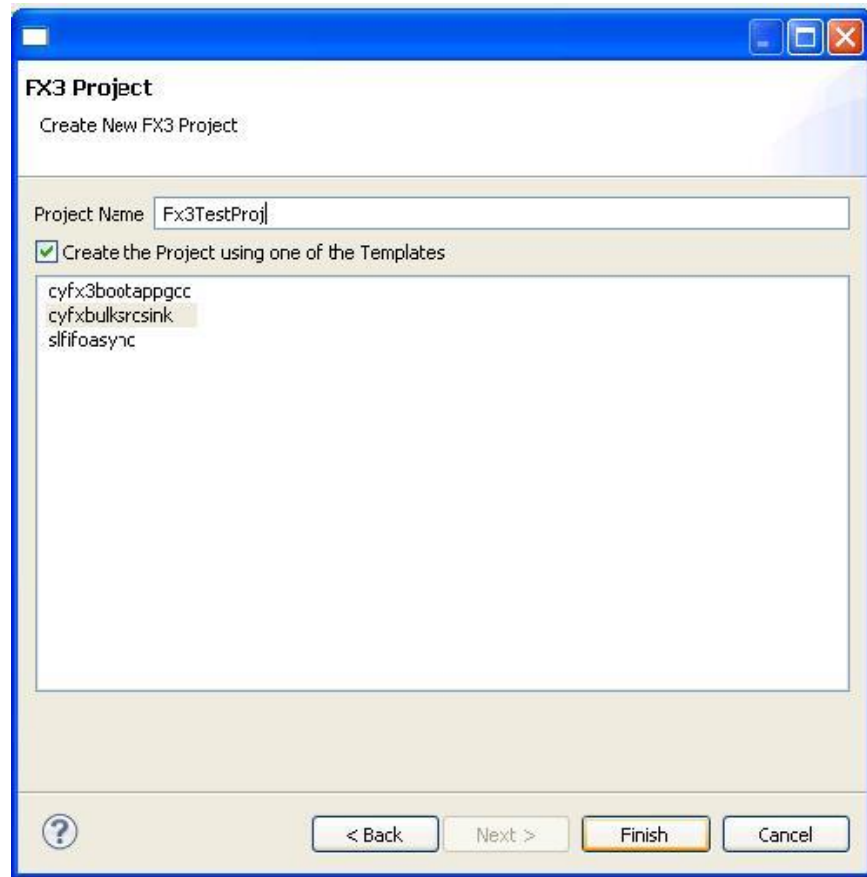

Figure 2-9: Creating the template based project

3 JTAG Debugging of Firmware Projects



The ARM9 core on the FX3 and related devices support the standard ARM JTAG TAP block and all of the JTAG pins are made available on the device package. This means that any standard JTAG debugger and tools can be used to debug FX3 firmware projects.

The following sub-sections provide instructions on how the Segger J-Link Debug Probe and the Cypress CY7C65215 USB serial device can be used for debugging firmware projects. Similar sequences can be followed when using other debug probes.

3.1 Debugging using Segger J-Link

The following procedure can be used to debug FX3 projects from the Eclipse IDE on all supported platforms (Windows, MacOS and Linux).

Download and install the latest J-Link GDB Server software from the Segger web page: <https://www.segger.com/jlink-gdb-server.html>

The command line version of the GDB server program is used for the following steps.

1. Select and right-click on the project to be debugged, and select the “Debug As -> Debug Configurations...” option.

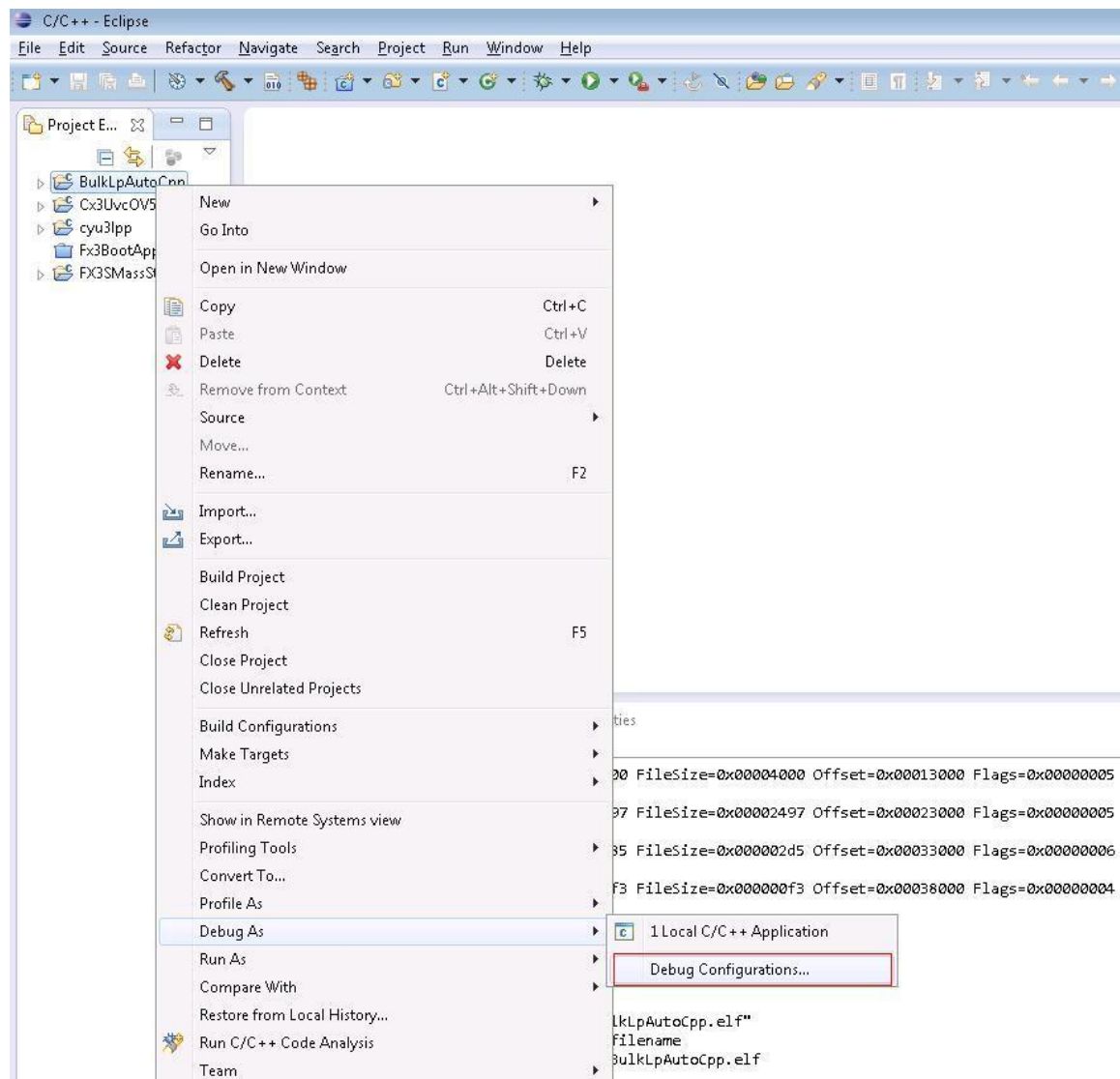

Figure 3-1: Creating debug configuration: Start

- In the Debug Configurations popup window, right-click the “GDB Segger J-Link debugging” option and select “New”.

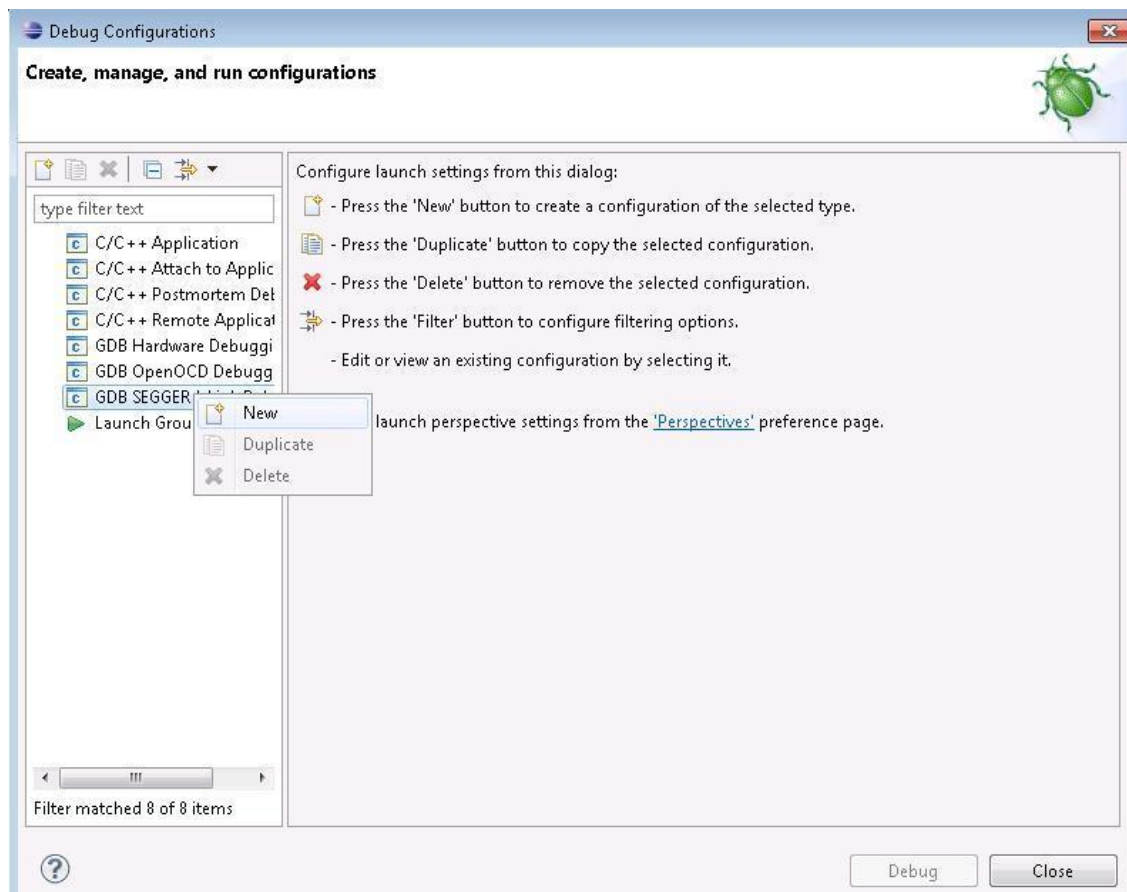

Figure 3-2: Creating debug configuration: Segger J-Link

- A “<ProjName> Debug” configuration will be created. The settings for the configuration need to be entered as below.

4. No changes are required under the “Main” tab.

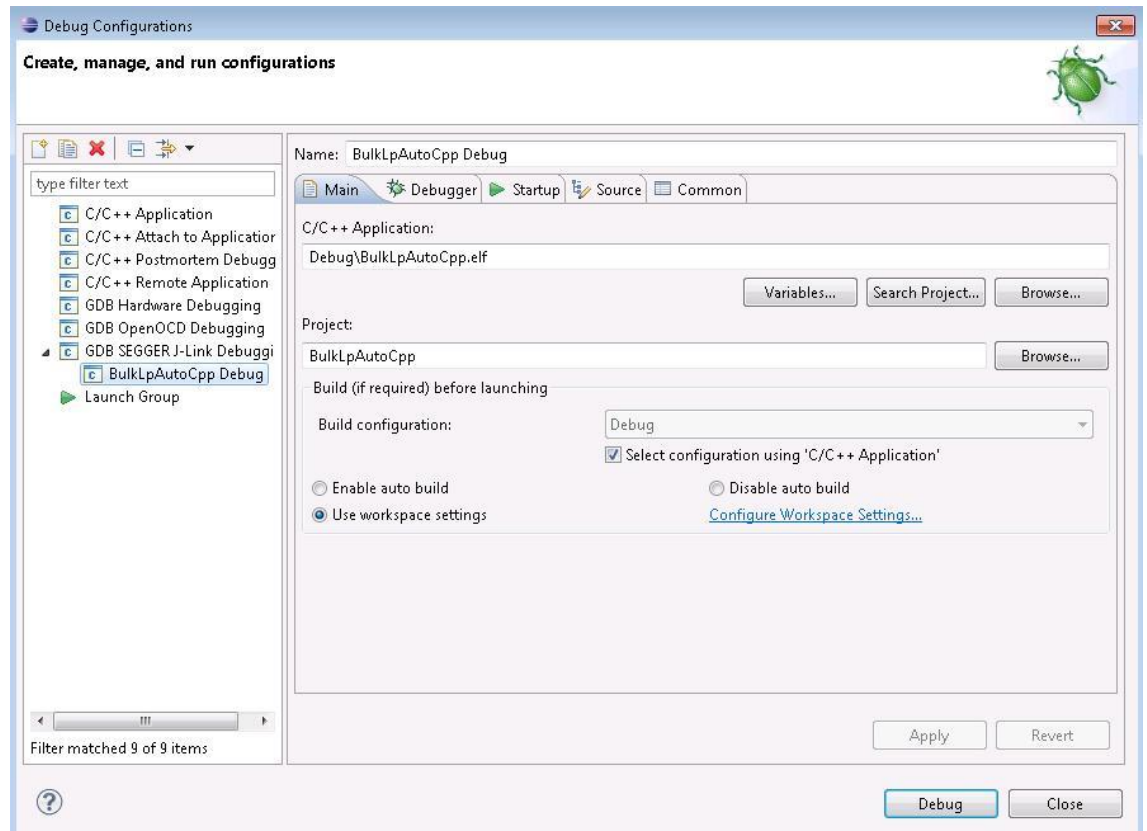

Figure 3-3: Creating debug configuration: Main tab

- On the “Debugger” tab, browse and select the path to the J-Link GDB Server executable, specify “ARM9” as the Device Name and select JTAG as the debug interface.

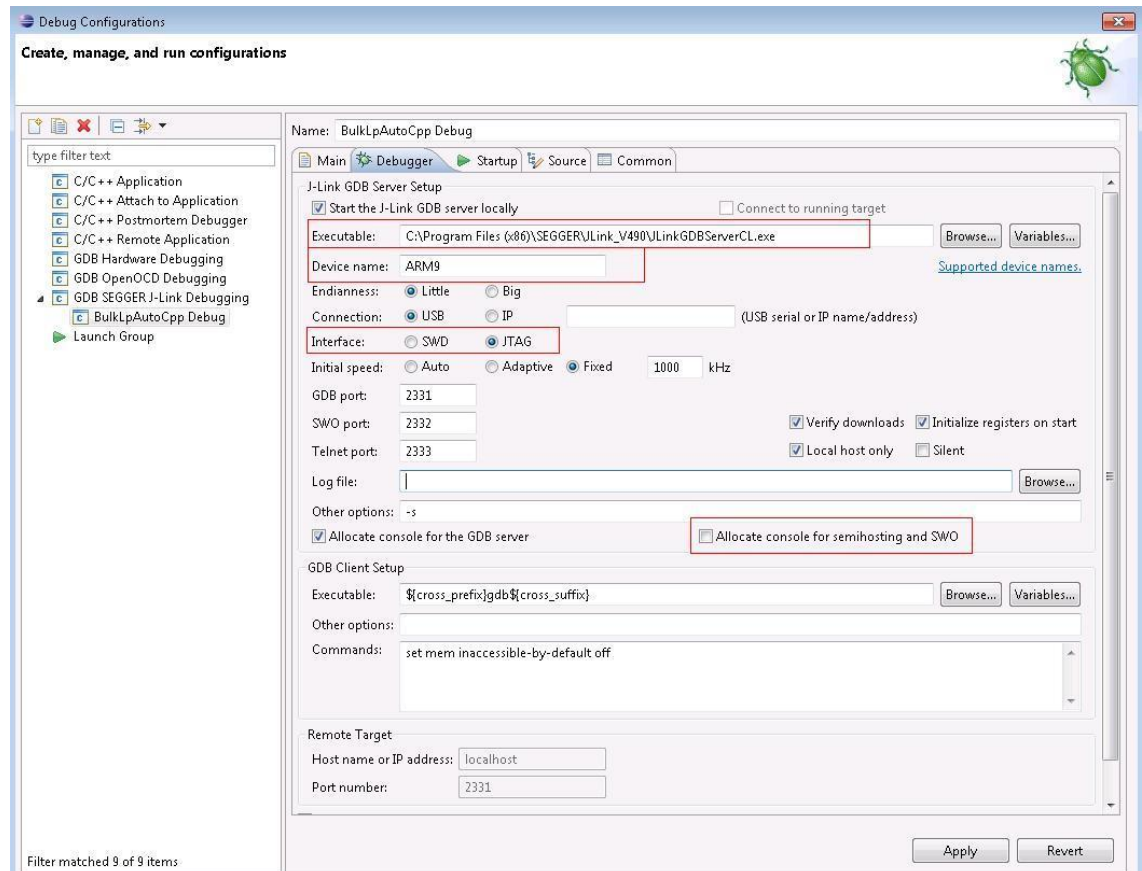

Figure 3-4: Creating debug configuration: Debugger tab

- On the “Startup” tab, disable the “Enable flash breakpoints”, “Enable semihosting” and “Pre-run reset and halt” options using the corresponding checkboxes.

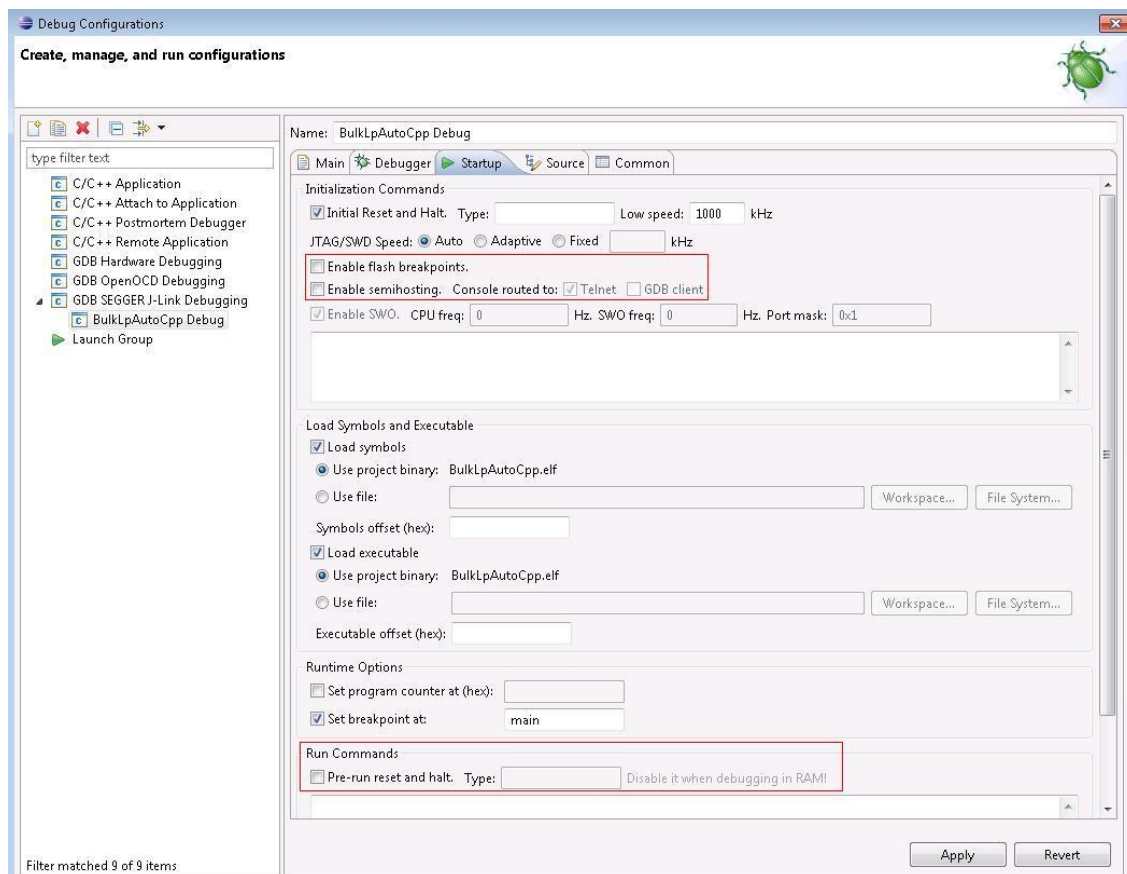

Figure 3-5: Creating debug configuration: Startup Tab

- Click on “Apply” to save settings, and then click on “Debug” to start debugging.

- If a “Confirm Perspective Switch” popup window (as shown below) appears, select “Yes” to switch to the Debug perspective. The “Remember my decision” checkbox can be ticked to prevent this popup from appearing in subsequent debug sessions.

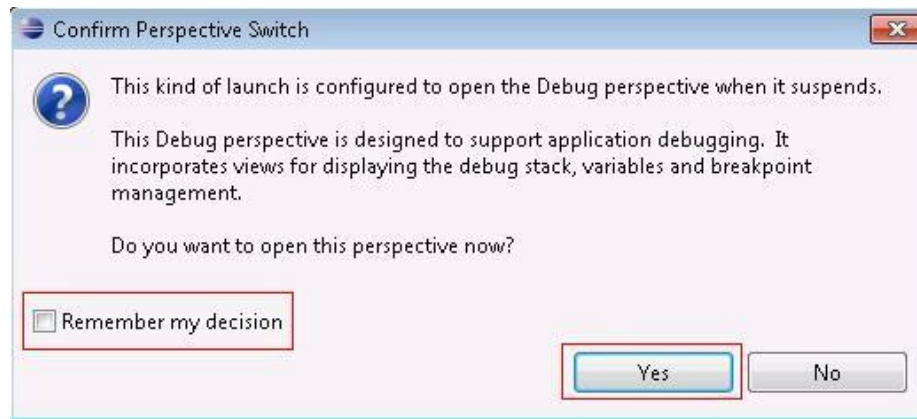

Figure 3-6: Creating debug configuration: Perspective switch

- Execution stops at the “main ()” function. Additional breakpoints can be placed at this stage, and the Resume, Step Into or Step Over actions can be used to run through the code.

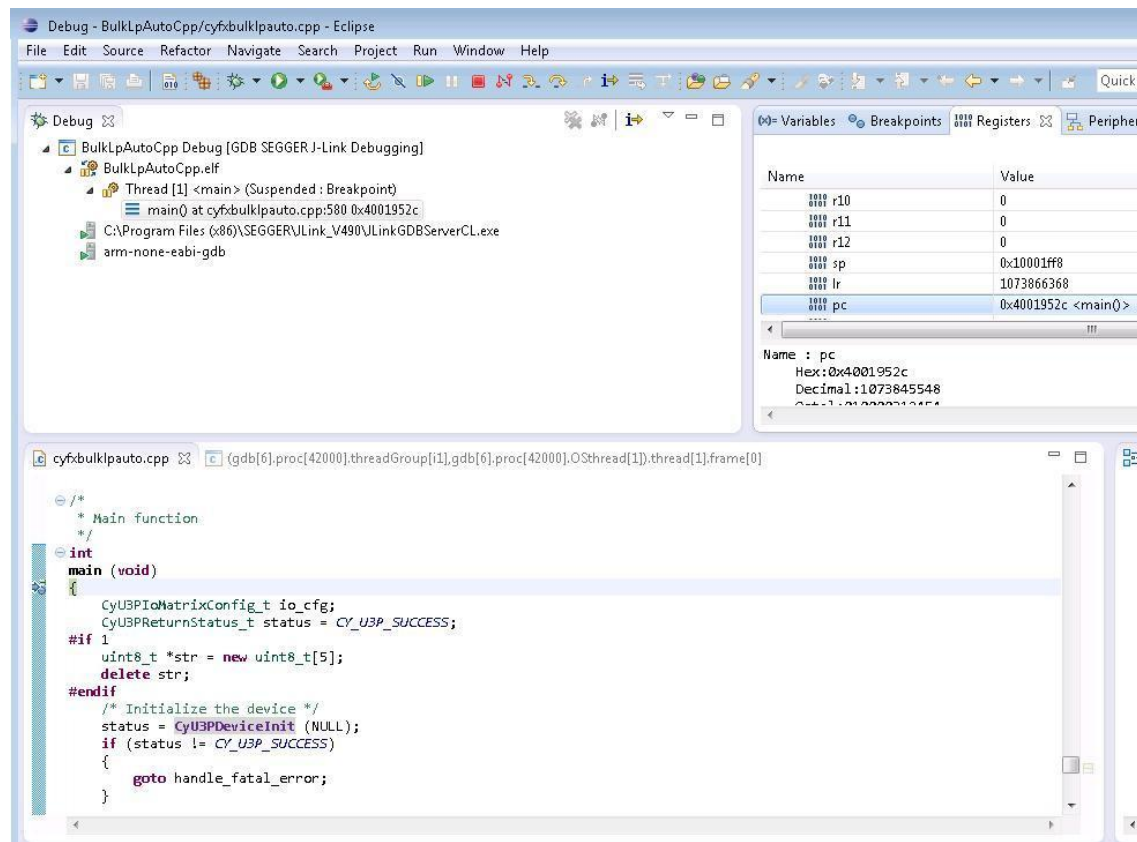

Figure 3-7: Debug session stopped at breakpoint

10. Click on “Terminate” to stop the debug session.

3.2 Debugging with OpenOCD

Open On-Chip Debugger (OpenOCD) is an open source debugger implementation that supports a variety of debugger probes. The CY7C65215 Cypress USB Serial part on the CYUSB3KIT-003 development kit provides a debugger interface that works with OpenOCD.

A version of OpenOCD binary that supports debugging using the CY7C65215 part is provided with the FX3 SDK, under the OpenOCD folder. This binary is based on the OpenOCD 0.8.0 release and only supports the CY7C65215 part as a debug interface.

If any other OpenOCD compliant debug probe (such as the Olimex ARM JTAG debug probe) is being used, replace the OpenOCD binary provided with a version that supports the target debug probe. The rest of the instructions are interface independent, and apply to any OpenOCD compliant debug probe.

The latest version of OpenOCD sources can be downloaded from:
<http://sourceforge.net/projects/openocd/files/openocd/>. Pre-compiled binaries for Windows can be obtained from:

<http://www.freddiechopin.info/en/download/category/4-openocd>.

Note: When using OpenOCD on Linux or Mac platforms, the libraries that the OpenOCD binary depends on; need to be copied to the system folders. Please change to the <FX3_INSTALL_PATH>/OpenOCD/<platform> folder and run the script.sh script to do this. No specific installation steps are required on Windows platforms.

The procedure for setting up OpenOCD based JTAG debugging is shown below:

1. Select and right-click on the project to be debugged, and select the “Debug As -> Debug Configurations...” option. See Figure 3-1.

2. In the Debug Configurations popup window, right-click the “GDB OpenOCD debugging” option and select “New”.

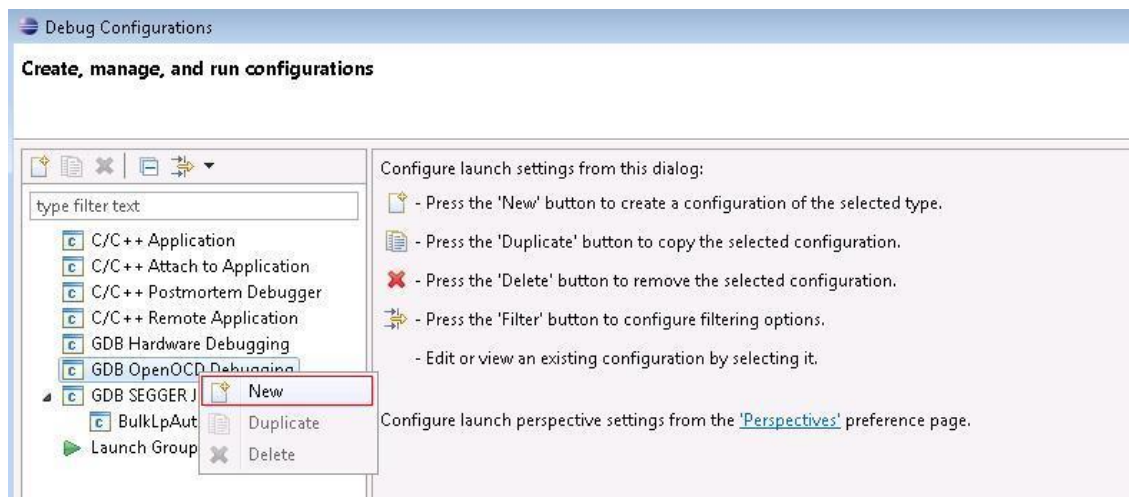

Figure 3-8: Creating debug configuration: OpenOCD

3. A “<ProjName> Debug” configuration will be created. The settings for the configuration need to be entered as described in the next steps.

4. No changes are required under the “Main” tab.

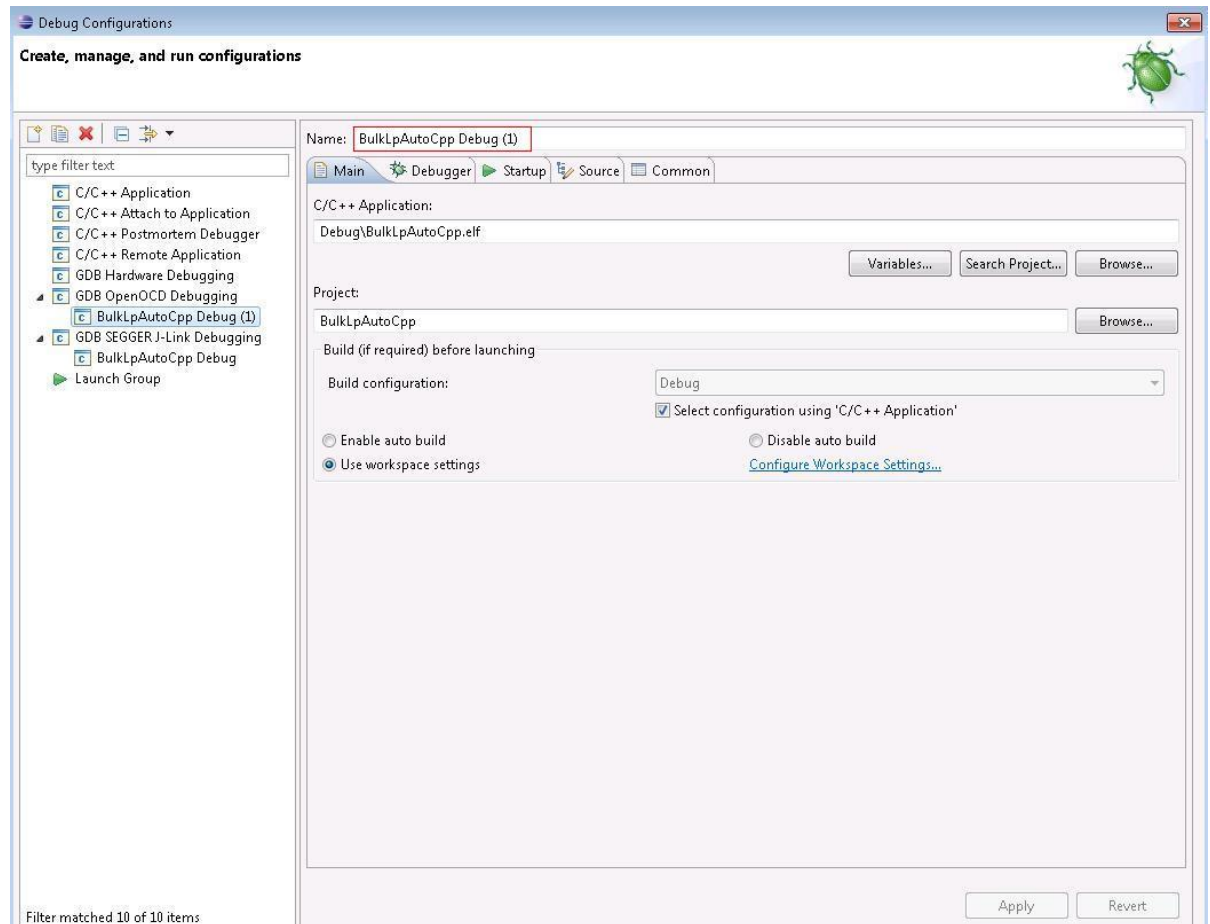

Figure 3-9: Creating OpenOCD debug configuration: Main tab

- On the “Debugger” tab, browse and select the path to the OpenOCD executable, and selecting the OpenOCD configuration file provided with the SDK under “Config options”. Please note that the full path to the config file needs to be provided here, and may need to be enclosed in quotes if it includes spaces.

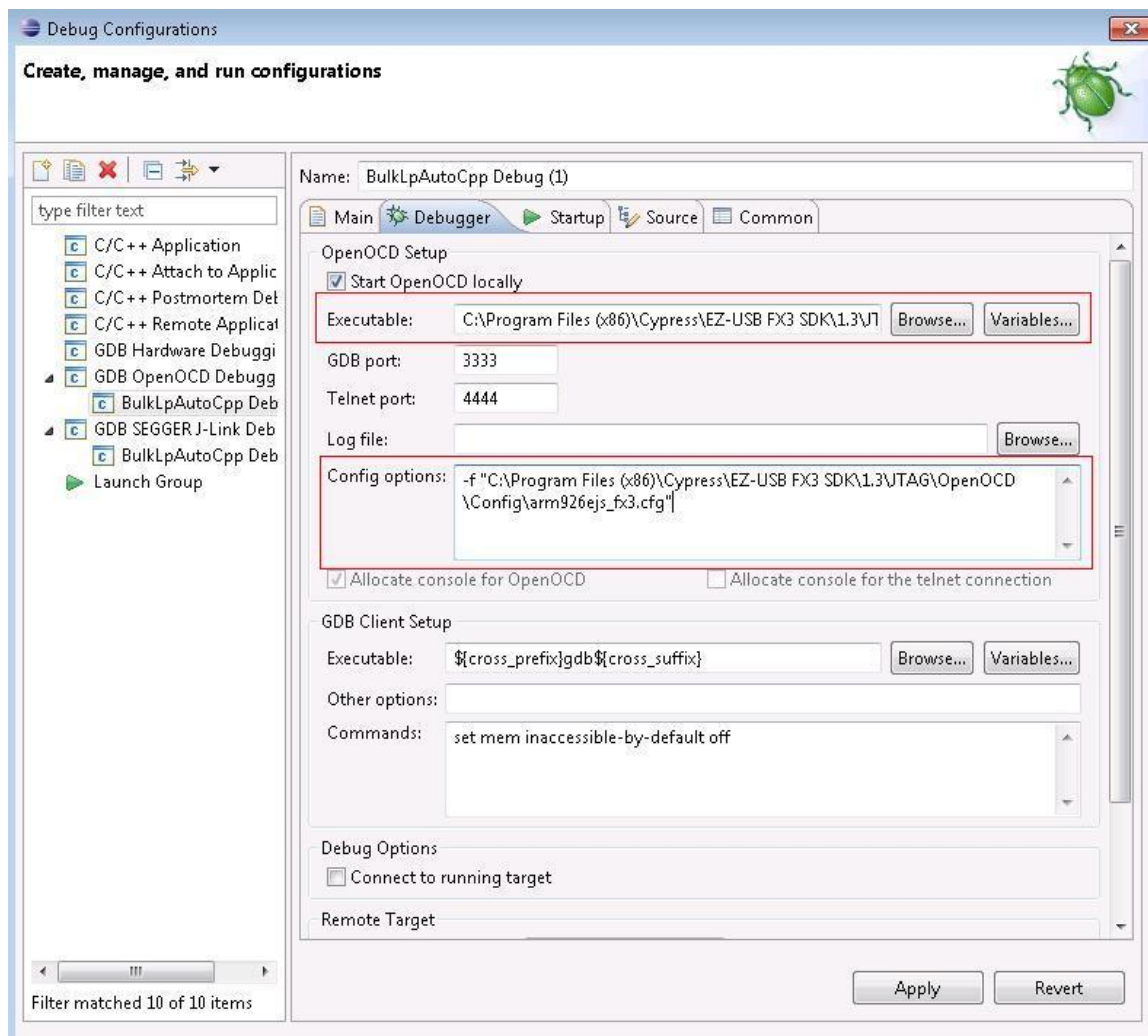

Figure 3-10: Creating OpenOCD debug configuration: Debugger tab

- On the “Startup” tab, disable the “Enable ARM semihosting” and “Pre-run reset” options using the corresponding checkboxes.

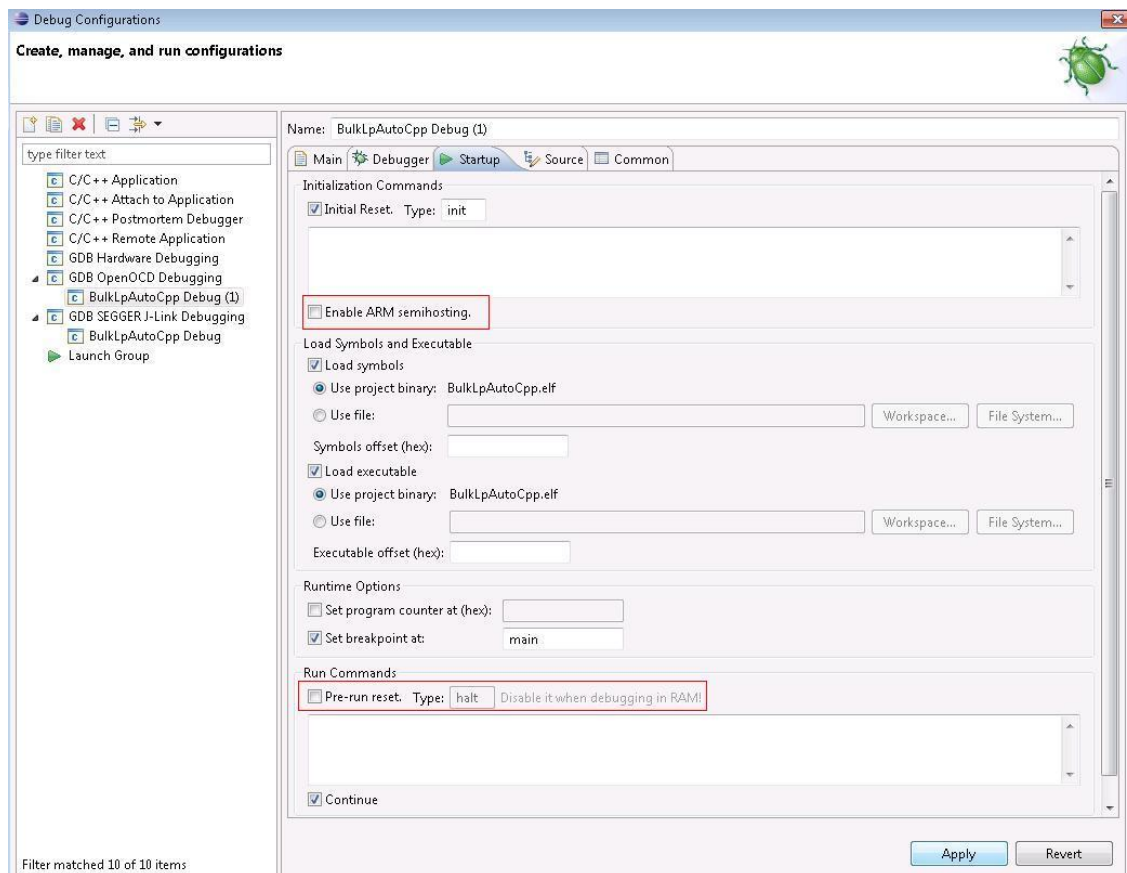

Figure 3-11: Creating OpenOCD debug configuration: Startup Tab

- Click on “Apply” to save settings, and then click on “Debug” to start debugging.
- If a “Confirm Perspective Switch” popup window (as shown below) appears, select “Yes” to switch to the Debug perspective. The “Remember my decision” checkbox can be ticked to prevent this popup from appearing in subsequent debug sessions. See Figure 3-6.
- Please note that firmware download using the CY7C65215 debug probe is a slow process and can take about 30 to 40 seconds. Wait for the firmware download to be completed before the session is ready for debugging.
- Execution stops at the “main ()” function. Additional breakpoints can be placed at this stage, and the Resume, Step Into or Step Over actions can be used to run through the code. See Figure 3-7.
- Click on “Terminate” to stop the debug session.

4 CX3 Configuration Utility



This section provides an introduction to MIPI CSI-2 interface on the CX3 device and provides a usage guide for the CX3 Configuration tool available as part of the Cypress EZ USB Suite Eclipse based IDE. More details on the CX3 part are available on the Cypress website at <http://www.cypress.com/cx3/>

4.1 Introduction to the CX3 device

The CX3 is a variant of the FX3 device that features an integrated MIPI CSI-2 receiver mated to the GPIF as shown in the CX3 Logic block diagram. This device provides the ability to add USB 3.0 connectivity to Image Sensors implementing the MIPI CSI-2 interface.

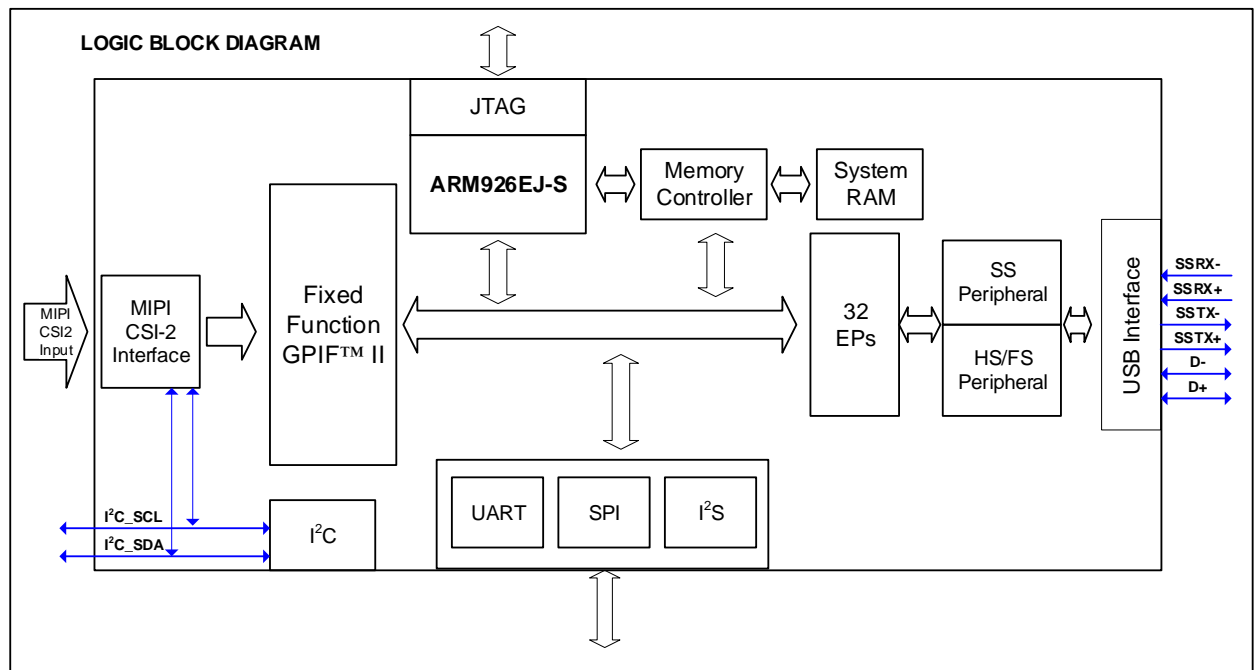

Figure 4-1: CX3 Device Block Diagram

The MIPI CSI-2 interface on the CX3 supports 1 to 4 CSI-2 data lanes and RAW8/10/12/14, YUV422, and RGB888/666/565 image formats. It reads image

data from the sensor, de-packetizes it and sends it in to the parallel interface of the fixed-function GPIF-II interface on the CX3.

As the GPIF-II signals on CX3 are connected internally to the MIPI CSI-2 Interface block, it is not possible make use of the GPIF-II to talk to any external devices. The control signals on the interface are also fixed, and only the width of the data bus can be selected from the values of 8-bit, 16-bit and 24-bits. CX3 firmware applications typically make use of a pre-defined GPIF-II configuration with changes being made only to the data bus width and the counter limits used.

Support for the MIPI CSI-2 interface is provided through a new firmware library added to the SDK (cyu3mipicsi.a). The APIs provided by the library and the data structures and enumerations used by this interface are provided through the cyu3mipicsi.h header file.

4.2 CX3 MIPI CSI-2 interface

4.2.1 Data Lanes

The MIPI CSI-2 interface on the CX3 supports 1 to 4 CSI-2 data lanes each capable of transfers of up to 1 Gbps. The number of data lanes to be selected for a CX3 application will depend upon the number of data lanes provided by the Image Sensor and the total required data transfer rate.

4.2.2 MIPI CSI-2 stream formats supported by the CX3

The MIPI CSI-2 interface on the CX3 supports the following stream formats and output modes:

Table 4-1: Stream formats supported by CX3

Format and Mode	CX3 Enumeration Type	Description	CSI-2 Data Type	Output Stream
RAW8	CY_U3P_CSI_DF_RAW8	Bayer format 8-bits per pixel data stream.	0x2A	8-Bit Output: RAW[7:0]
RAW10	CY_U3P_CSI_DF_RAW10	Bayer format 10-bits per pixel data stream.	0x2B	16-Bit Output: 6'b0, RAW[9:0]
RAW12	CY_U3P_CSI_DF_RAW12	Bayer format 12-bits per pixel data stream.	0x2C	16-Bit Output: 4'b0,RAW[11:0]
RAW14	CY_U3P_CSI_DF_RAW14	Bayer format 14-bits per pixel data stream.	0x2D	16-Bit Output: 2'b0,RAW[13:0]
RGB888	CY_U3P_CSI_DF_RGB888	RGB 888 format 24- bits per pixel data stream.	0x24	24-Bit Output: R[7:0],G[7:0],B[7:0]
RGB666 Mode 0	CY_U3P_CSI_DF_RGB666_0	RGB 666 format 24- bits per pixel data stream.	0x23	24-Bit Output: 2'b0,R[5:0],2'b0,G[5:0], 2'b0,B[5:0]

Format and Mode	CX3 Enumeration Type	Description	CSI-2 Data Type	Output Stream
RGB666 Mode 1	CY_U3P_CSI_DF_RGB666_1	RGB 666 format 24- bits per pixel data stream.	0x23	24 Bit Output: 6'b0,R[5:0],G[5:0], B[5:0]
RGB565 Mode 0	CY_U3P_CSI_DF_RGB565_0	RGB 565 format 24- bits per pixel data stream.	0x22	24 Bit Output: 2'b0,R[4:0],3'b0,G[5:0], 2'b0,B[4:0],1'b0
RGB565 Mode 1	CY_U3P_CSI_DF_RGB565_1	RGB 565 format 24- bits per pixel data stream.	0x22	24 Bit Output: 3'b0,R[4:0],2'b0,G[5:0], 3'b0,B[4:0]
RGB565 Mode 2	CY_U3P_CSI_DF_RGB565_2	RGB 565 format 16-bits per pixel data stream.	0x22	16 Bit Output: R[4:0],G[5:0], B[4:0]
YUV422 8-Bit Mode 0	CY_U3P_CSI_DF_YUV422_8_0	YUV422 format 8-bits per pixel data stream.	0x1E	8 Bit Output: P[7:0] Data Order: U1,Y1,V1,Y2,U3,Y3,....
YUV422 8-Bit Mode 1	CY_U3P_CSI_DF_YUV422_8_1	YUV422 format 8-bits per pixel data stream.	0x1E	16 Bit Output: P[15:0] Data Order: {U1,Y1},{V1,Y2},{U3,Y3},{V3,Y4}...
YUV422 8-Bit Mode 2	CY_U3P_CSI_DF_YUV422_8_2	YUV422 format 8-bits per pixel data stream.	0x1E	16 Bit Output: P[15:0] Data Order: {Y1,U1},{Y2,V1},{Y3,U3},{Y4,V3}....
YUV422 10-Bit	CY_U3P_CSI_DF_YUV422_10	YUV422 format 10-bits per pixel data stream.	0x1F	16 Bit Output: 6'b0,P[9:0] Data Order: U1,Y1,V1,Y2,U3,Y3,V3,Y4.

If the GPIF interface used is larger than the width of the output stream (e.g. if a 24-bit GPIF II interface is used for the CY_U3P_CSI_DF_YUV422_8_1 type) the upper bits on the GPIF II interface will be padded with 0s.

4.2.3 MIPI CSI-2 interface clocks

The primary clocks on the MIPI CSI-2 interface of the CX3 are shown in Figure 4-2 below.

The interface takes a reference clock as its input and generates the required clocking using a PLL and multiple clock dividers on the PLL generated clock. Clock configuration parameters are a part of the *CyU3PMipicsiCfg_t* structure which passed to the *CyU3PMipicsiSetIntfParams()* API to configure the CSI-2 interface.

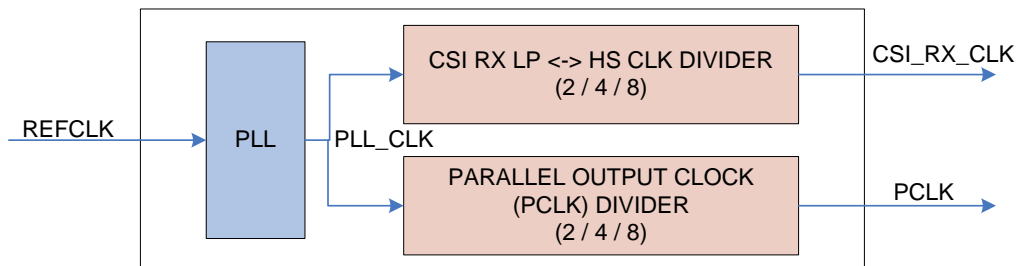

Figure 4-2: CX3 MIPI CSI-2 Interface Clocks

A brief description of each of the clocks is provided below:

1. Reference Clock (REFCLK)

This is the input reference clock provide to the MIPI-CSI interface. This input clock should be between 6 and 40 MHz.

2. PLL Clock (PLL_CLK)

The PLL_CLK is the primary clock on the MIPI CSI-2 interface. The minimum legal value for PLL clock is 62.5 MHz and maximum legal value for the PLL is 1 GHz.

All other internal/output clocks are derived from this clock.

The PLL clock frequency is generated from the Input Reference Clock using the following equation:

$$\text{PLL_CLK} = \text{REFCLK} * [(\text{pllFbd} + 1) / (\text{pllPrd} + 1)] / (2^{\text{pllFRS}})$$

where

pllPrd is the input divider whose range is between 0 and 0x0F.

pllFbd is the feedback divider whose range is between 0 and 0x1FF.

pllFRS is the frequency range selection parameter which takes the following values:

0 if PLL Clock is between 500MHz- 1GHz.

1 if PLL Clock is between 250MHz- 500MHz.

2 if PLL Clock is between 125MHz- 250MHz.

3 if PLL Clock is between 62.5MHz- 125MHz.

E.g.:

If RefClk is 19.2 MHz, plIFbd is 69, plIPrd is 1, and PLL Clock range is in the 500MHz-1GHz range (i.e. plIFrs = 0),

$$\begin{aligned}\text{PLL_Clock (MHz)} &= 19.2 * [(69+1)/(1+1)]/(2^0) \\ &= 19.2 * [70/2]/1 \\ &= 672 \text{ MHz}\end{aligned}$$

For the same values, changing PLL frequency range to 125-250MHz (plIFrs = 2) will change the PLL Clock value to

$$\begin{aligned}\text{PLL_Clock (MHz)} &= 19.2 * [(69+1)/(1+1)]/(2^2) \\ &= 19.2 * [70/2]/4 \\ &= 168 \text{ MHz}\end{aligned}$$

3. CSI RX LP \leftrightarrow HS Transition Clock

This clock is used for detecting the CSI link LP \leftrightarrow HS transition. It is generated by dividing the PLL_Clock by a value of 2, 4 or 8.

The minimum value for this clock is 10Mhz and maximum value for this clock is 125MHz.

4. Output Parallel Clock (PCLK)

This clock is the PCLK output which drives the fixed-function GPIF interface on the CX3. It is generated by dividing the PLL_Clock by a value of 2, 4 or 8.

The maximum value for this clock is 100MHz.

4.3 Configuring the CX3 Device

The typical CX3 application is a USB Video Class (UVC) compliant Camera application that streams video or still image data captured by an Image Sensor to a host PC. Most parts of a CX3 system design are common, with the only variations being in the Image Sensor and data formats chosen.

The typical steps involved in UVC implementations using the CX3 device are:

1. Configuring the image sensor as required.
2. Configuring the MIPI CSI-2 interface on the CX3 device based on the image sensor settings.
3. Defining the USB descriptors for the application based on the image formats to be supported.
4. Implementing the actual image streaming logic using CX3/FX3 APIs.
5. Implementing the sensor control operations required to handle requests on the Video Control interface (e.g. brightness, pan – tilt – zoom etc.)

The EZ-USB Suite application provides a CX3 Configuration utility that helps in steps 2, 3 and 4. The actual image sensor control (step 1) and the control interface handling (step 5) are sensor dependent, and not handled by the tool.

4.3.1 MIPI CSI-2 Configuration

The MIPI CSI-2 interface on CX3 is configured using the *CyU3PMipicsiSetIntfParams()* API. This API takes an input parameter of type *CyU3PMipicsiCfg_t* which contains various configurations like output data format, clock dividers and configuration parameters, number of CSI data lanes to use, horizontal resolution etc.

The CSI Configuration Utility generates the data required to configure the interface in the form of C code which can be embedded into the firmware application.

4.3.2 Defining the USB Descriptors

The UVC specification defines the format for the USB configuration descriptors for all UVC compliant devices. The size of the configuration descriptor can stretch to 200 bytes or more depending on the number and types of video formats and resolutions supported. Putting together the descriptors in a fully spec compliant manner across all three USB connection speeds (SuperSpeed, Hi-Speed and Full Speed) is a cumbersome process.

The CSI Configuration Utility generates the USB descriptors based on the settings provided. The descriptor data is generated in the form of C code which can be embedded into the firmware application.

4.3.3 Video Streaming Logic

The firmware design and implementation to handle video streaming includes elements such as:

1. Defining the buffering requirements for the video stream.
2. Setting up the DMA connection from the GPIF-II interface to the USB endpoint
3. Handling Video Streaming control requests to negotiate the video format and resolution.
4. Managing the actual video data transfer with UVC header addition.

The CSI configuration tool generates C header and source files that implement this logic. These files can be used along with the CSI-2 configuration file and the USB descriptor file to create the UVC firmware project.

The next section describes the usage of the MIPI CSI-2 Configuration tool provided as part of the EZ-USB Suite IDE.

4.4 Using the CSI Configuration Utility

4.4.1 Creating a new CX3 Configuration Project

From the File menu of the EZ USB Suite IDE, select the **New** → **Other** option.

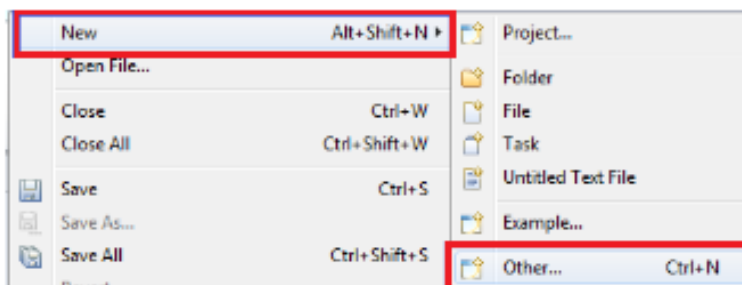

Figure 4-3: CX3 Configuration File Creation Menu

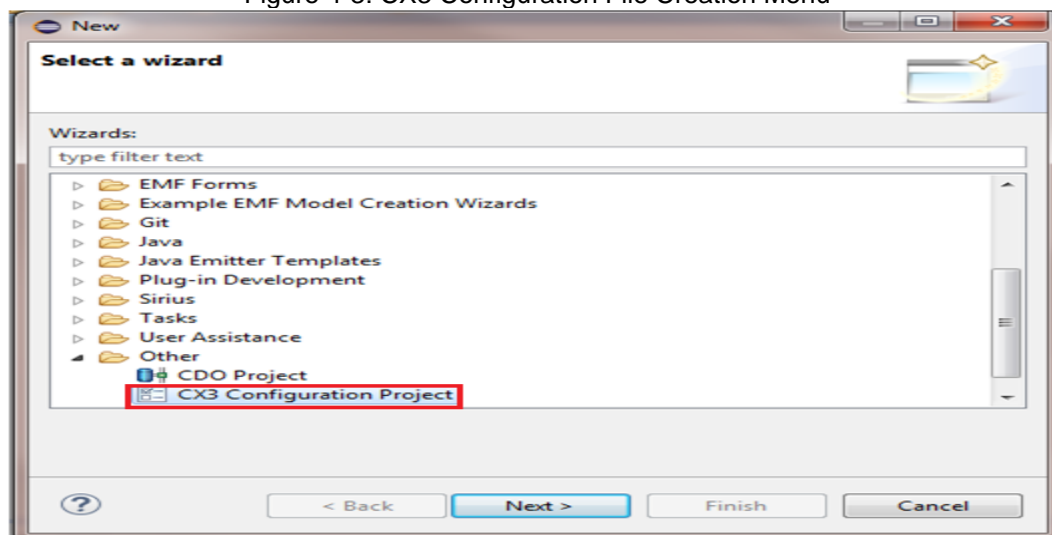

Figure 4-4: CX3 Configuration Project Creator

4.4.2 Image Sensor Selection and Configuration

The first step in configuring the CX3 UVC project is to define the properties of the image sensor being used in the system. This includes properties like the type of sensor, still image and video capture support, the format and resolution of the images etc.

Configurations for the Aptina AS0260 and OmniVision OV5640 sensors are provided as part of the tool, and you can use these directly if these sensors are being used. If other sensors are being used, the wizard can be used to input the sensor properties for conversion into the required format.

4.4.2.1 CX3 Configuration Project Creation

The CX3 Configuration Project Creation Wizard provides three possible alternatives for configuring the newly created project:

1. Create a Configuration with Basic Settings
2. Select a Pre-Defined Configuration
3. Select an User defined Configuration

The steps for configuring the MIPI CSI-2 interface and image sensor using each of the three possible options are described in the following sub-sections.

4.4.2.1.1 Configuration with Basic Settings

1. Click on **Create a Configuration with Basic Settings** Radio Button and provide a new name to the project. Click on **Finish** button to start generating relevant configuration data.

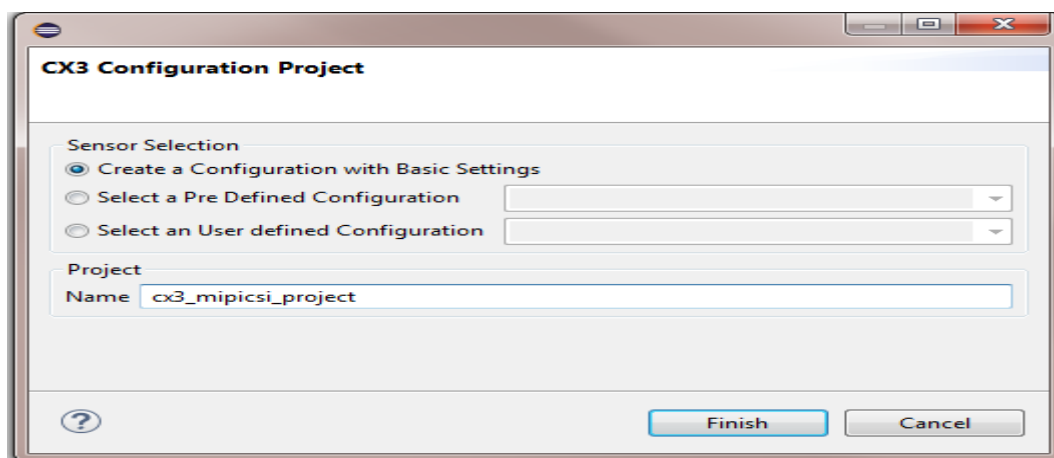

Figure 4-5: CX3 Configuration Project Selector

2. An empty **Image Sensor Configuration** window with no pre-defined sensor and frame opens up. A new CX3 Project is created under the Eclipse workspace as well.

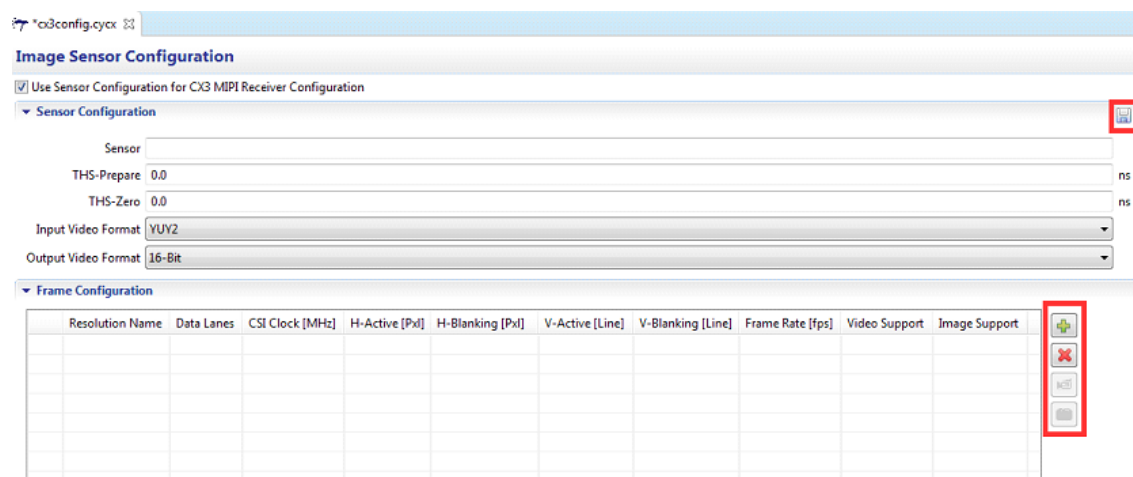

Figure 4-6: Image Sensor Configuration Stage

3. Input the desired sensor configuration and select the appropriate video format from the dropdown list provided in the configuration window.
 - a. A name string can be provided for the sensor.
 - b. The THS-Prepare value represents the duration for which the sensor drives the CSI data lane LP-00 line state before starting the HS transmission. This value can be determined from the image sensor datasheet.
 - c. The THS-Zero value represents the duration for which the sensor drives the HS-0 state before transmitting the sync sequence. This value can also be determined from the image sensor datasheet.
 - d. The Input Video Format represents the video picture encoding format supported by the sensor. This has to be selected from the drop-down list.
 - e. The Output Video Format represents the data size of each pixel in the image stream. This has to be selected from the drop-down list.

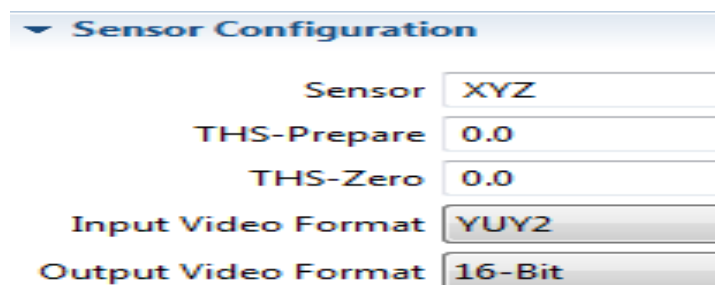

Figure 4-7: Image Sensor Configuration

4. Each Image Sensor may be capable of supporting multiple video resolutions and frame rates. The Frame Configuration area of the Image Sensor configuration wizard can be used to input the supported (desired) frame resolutions and frame rates. The properties to be specified for each frame configuration includes:
 - a. A name string to identify the configuration.
 - b. The number of CSI-2 data lanes used.
 - c. The CSI-2 clock frequency used.
 - d. The H-Active value represents the frame width in number of pixels.
 - e. The H-Blanking value represents the horizontal blanking period after each line of image data is transferred.
 - f. The V-Active value represents the frame height in number of pixels.
 - g. The V-Blanking value represents the vertical blanking period after each frame is transferred, and is represented in terms of number of lines.
 - h. The streaming rate in terms of number of frames per second.
 - i. Support for video and/or still image capture.

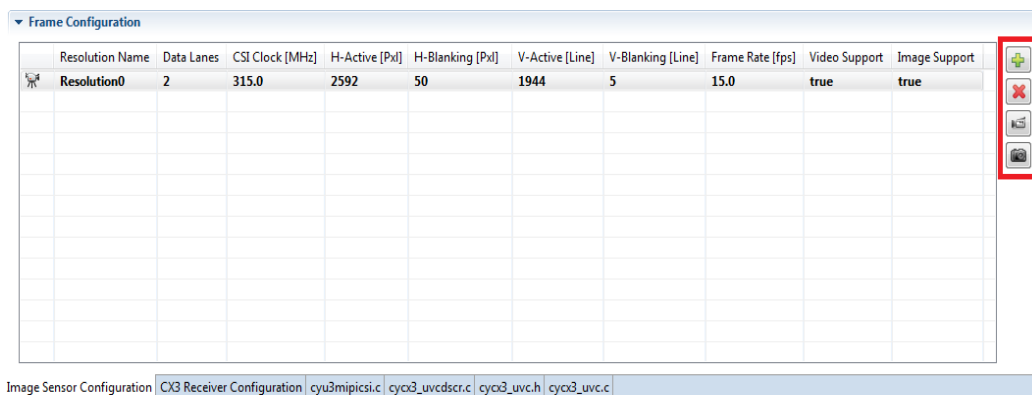

Figure 4-8: Frame Configuration

Multiple user defined frame configurations can be added by pressing (+) button for every configuration required. Frame configurations can also be deleted from the current project by pressing (X) button. Deleted configurations can be reinstated by pressing using the undo key (Ctrl+Z). Still Image and Video support in CX3 project can be enabled or disabled using the buttons below remove (X) button.

Entering any invalid configuration parameters will trigger warnings at the next stage, i.e., CX3 receiver configuration.

The configuration parameters can be stored as a custom configuration by pressing the **Save** button located at upper right corner of the window. Once

saved, these configurations will be available for selection as User defined configurations in other projects.

4.4.2.1.2 Using Pre-Defined Configurations

1. Click on the **Select a Pre-Defined Configuration** Radio Button and select any of the pre-defined configurations from the dropdown list. Configurations for the Aptina AS0260 and OmniVision 5640 sensors are provided in this version of the configuration utility. Provide a name for the newly created project and click on **Finish** button to start generating project configuration data.

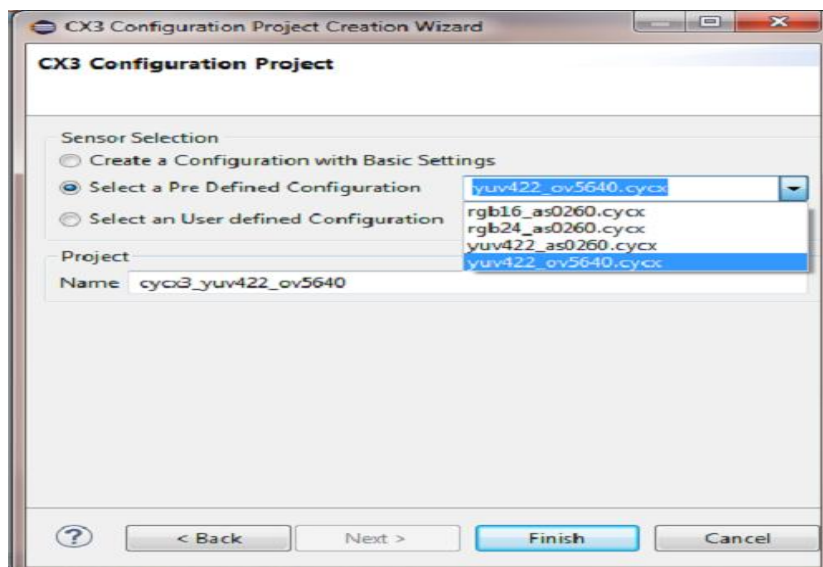

Figure 4-9: CX3 Configuration Project Selector

2. **The Image Sensor Configuration** window with pre-loaded sensor and frame configurations pops up. A new firmware project is created under the Eclipse workspace as well.

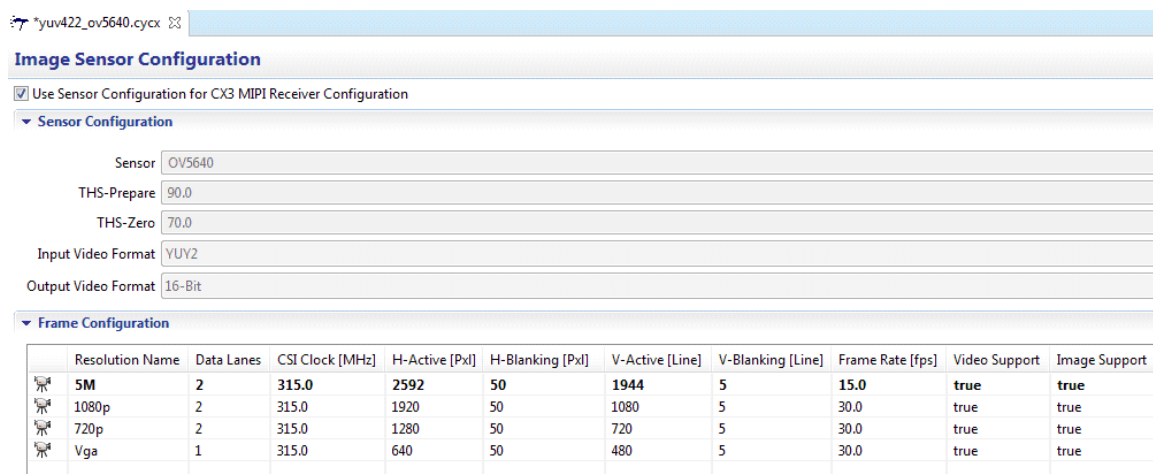

Figure 4-10: Using pre-defined Image Sensor Configurations

The Image Sensor Configuration window lists the pre-defined sensor and frame configurations for the selected Image Sensor. Listed frame configurations can be deleted from the current project but cannot be altered with new values. Deleted configurations can be reinstated using the undo key (**Ctrl+Z**).

Configuration parameters cannot be modified in pre-defined configuration option, but can be stored as a custom configuration by pressing **Save** button located at upper right corner of window.

4.4.2.1.3 User Defined Configuration

A sensor configuration created and saved using the steps in Section 4.4.2.1.1, can be re-used to create new CX3 projects. To do this, click on **Select an User-Defined Configuration** Radio Button and select the desired configuration from the dropdown box. Name the newly created project and click on **Finish** button to start generating project configuration data.

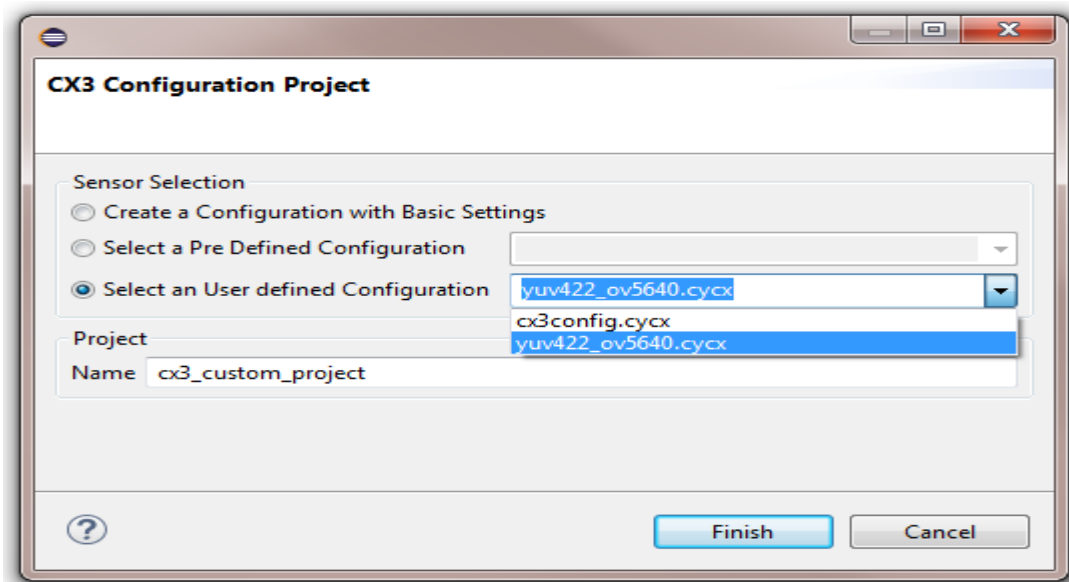

Figure 4-11: Selecting a user defined image sensor configuration

Refer to Section 4.4.2.1.2 for the steps to modify the image sensor configuration.

4.4.3 CX3 MIPI Receiver Configuration

Once the Image Sensor Configuration is complete, select the **CX3 MIPI Receiver Configuration** tab positioned at the bottom of currently opened window.

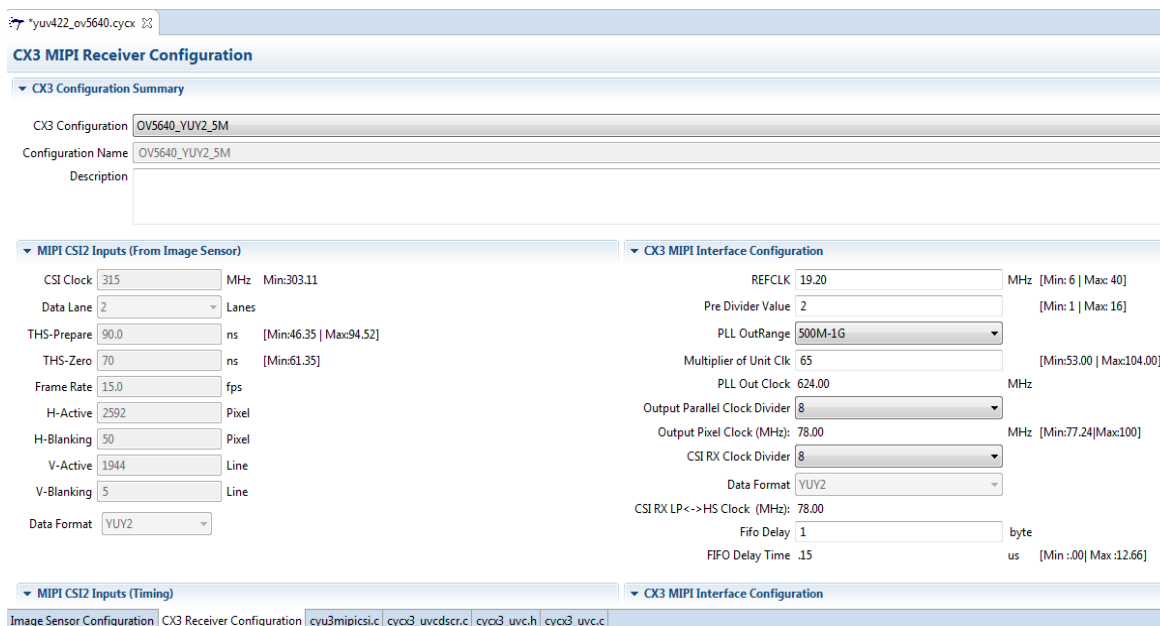

Figure 4-12: CX3 MIPI Receiver Configuration Stage

The CX3 MIPI Receiver Configuration Window is split into the following sub-sections:

4.4.3.1 CX3 Configuration Summary

The CX3 Configuration Summary section allows you to choose from among the frame configurations entered in the Image Sensor Configuration phase. When a frame configuration is selected from the drop-down list, the CSI-2 interface properties for the corresponding frame configuration will be displayed in the other sections of the window. The description text box allows you to provide a description for the configuration which will be added to the generated firmware source in the form of comments. Therefore, the description text should not contain `/*` or `*/` character combinations.



Figure 4-13: CX3 Configuration Summary

4.4.3.2 MIPI CSI-2 Inputs

The MIPI CSI-2 inputs section will display values passed from Image Sensor Configuration Stage for matching the Image Sensor’s output parameters. These values are provided for information, and cannot be modified in this tab. You have to go back to the Image Sensor Configuration tab in order to change any of these settings.

▼ MIPI CSI2 Inputs (From Image Sensor)			
CSI Clock	<input type="text" value="315"/>	MHz	Min:303.11
Data Lane	<input type="text" value="2"/>	Lanes	
THS-Prepare	<input type="text" value="90.0"/>	ns	[Min:46.35 Max:94.52]
THS-Zero	<input type="text" value="70"/>	ns	[Min:61.35]
Frame Rate	<input type="text" value="15.0"/>	fps	
H-Active	<input type="text" value="2592"/>	Pixel	
H-Blanking	<input type="text" value="50"/>	Pixel	
V-Active	<input type="text" value="1944"/>	Line	
V-Blanking	<input type="text" value="5"/>	Line	
Data Format	<input type="text" value="YUY2"/>		

Figure 4-14: MIPI CSI-2 Inputs

The CSI Clock frequency and the Data Lane entries along with the frame properties are used to compute the total input data throughput on the GPIF-II interface from the MIPI CSI-2 block.

4.4.3.3 CX3 MIPI Interface Configuration

The MIPI Interface Configuration section lists the CX3 MIPI CSI-2 configuration that has been computed based on the Image Sensor and frame properties. These value typically do not need to be modified, though the tool allows the user to make modifications.

▼ CX3 MIPI Interface Configuration			
REFCLK	<input type="text" value="19.20"/>	MHz	[Min: 6 Max: 40]
Pre Divider Value	<input type="text" value="2"/>		[Min: 1 Max: 16]
PLL OutRange	<input type="text" value="500M-1G"/>		
Multiplier of Unit Clk	<input type="text" value="65"/>		[Min:53.00 Max:104.00]
PLL Out Clock	<input type="text" value="624.00"/>	MHz	
Output Parallel Clock Divider	<input type="text" value="8"/>		
Output Pixel Clock (MHz):	<input type="text" value="78.00"/>	MHz	[Min:77.24 Max:100]
CSI RX Clock Divider	<input type="text" value="8"/>		
Data Format	<input type="text" value="YUY2"/>		
CSI RX LP<->HS Clock (MHz):	<input type="text" value="78.00"/>		
Fifo Delay	<input type="text" value="1"/>	byte	
FIFO Delay Time	<input type="text" value=".15"/>	us	[Min :.00] Max :12.66]

Figure 4-15: CX3 MIPI Interface Configurations

The first field in this section is the REFCLK frequency being provided to the block. This value along with the Pre Divider Value, PLL Out Range and Multiplier of Unit Clock is used to generate the plIPRD, plIFbd and plIFrs parameters which provide the PLL_CLK frequency using the equation listed in Section 4.2.3.

Once the PLL clock frequency has been set, the Output Pixel Clock (PCLK) and CSI RX clock frequency can be obtained by selecting the appropriate divider value as shown in the image below.



Figure 4-16: Selecting Clock Dividers

4.4.3.4 MIPI CSI2 Inputs / CX3 MIPI Interface Configuration

These values are calculated by the utility and are fixed for each frame configurations. These values serve as input and output parameters for the MIPI interface part on CX3, and are provided here for information.

MIPI CSI2 Inputs (Timing)			CX3 MIPI Interface Configuration		
H-Active	24.38	us	H Active	25.40	us
H-Total	30.72	us	PHY Time Delay Value	9.0	
V-Active	33.18	ms	H Active	0	
V-Total	33.34	ms	H Blanking	403.0	

Figure 4-17: MIPI Inputs

The CX3 MIPI Receiver Configuration window will throw warnings if any invalid parameters had been provided while configuring the sensor or by modifying the values in the CX3 MIPI Interface Configuration section. These warnings can be seen by hovering the mouse cursor over the warning symbols painted in color red. These warnings can be rectified by providing acceptable values in the sensor configuration tab.

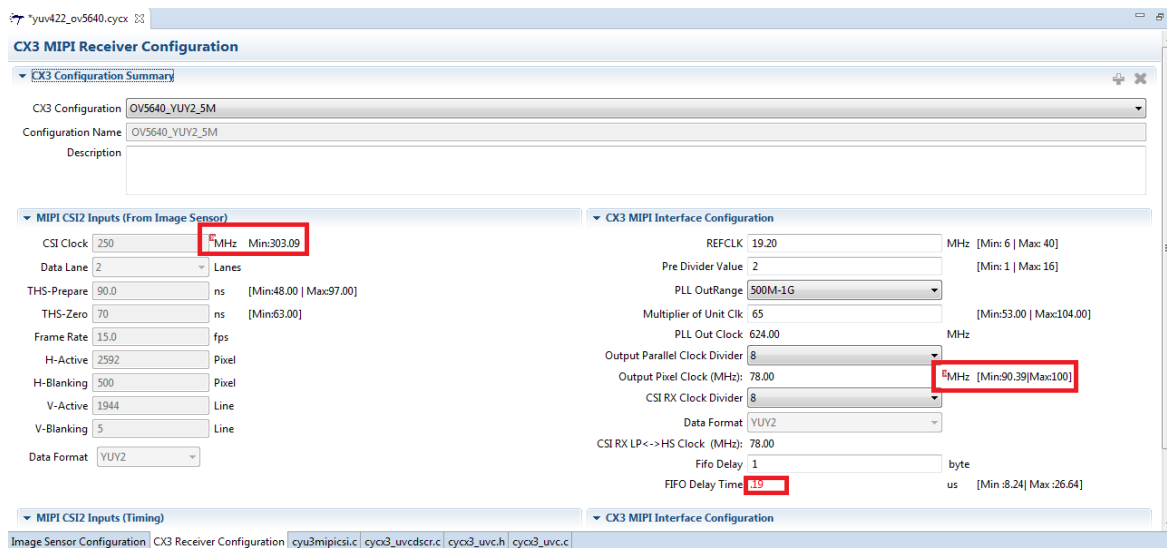

Figure 4-18: Warnings shown in CX3 MIPI Receiver Configuration tab
Please note that the warnings do not block the tool from generating the interface configuration source code. These only indicate errors detected during sanity checks performed by the tool, and can be over-ridden if the user is sure that the changes are valid.

4.4.4 Adding the Configuration to the Firmware Project

As mentioned above, the CX3 configuration utility generates the following pieces of C source code, which can be added to the application firmware project.

1. MIPI CSI-2 Configuration data for each frame configuration
2. USB descriptors for the UVC application
3. Header file defining the USB pipe and DMA buffer properties.
4. Source file implementing the actual video streaming logic.

The following sub-sections describe the procedure to add each of these to the firmware project.

4.4.4.1 Adding the CX3 CSI-2 Configurations

Move to the “cyu3mipicsi.c” tab once all CX3 MIPI CSI-2 Interface related configuration parameters are finalized. This tab contains the generated data structures that provide the CSI-2 configuration parameters corresponding to each frame configuration in the project.

This code can be saved to the related CX3 project, by pressing the **Save** button located at the upper right corner of window.

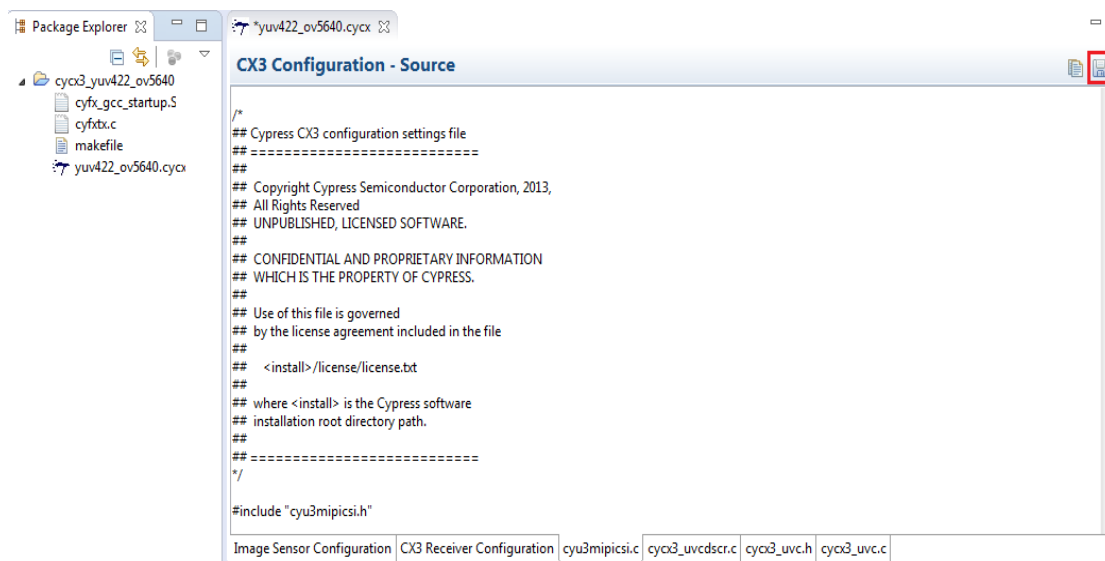

Figure 4-19: Utility generated CX3 Configuration Source file

4.4.4.2 Adding the USB Descriptors

Move to the “cycx3_uvcdscr.c” to view the USB descriptors that are generated based on the configuration provided. The USB configuration descriptors will contain frame descriptors corresponding to each of the frame configurations in the project. This file can be added to the related CX3 project by pressing the **Save** button located at the upper right corner of window.

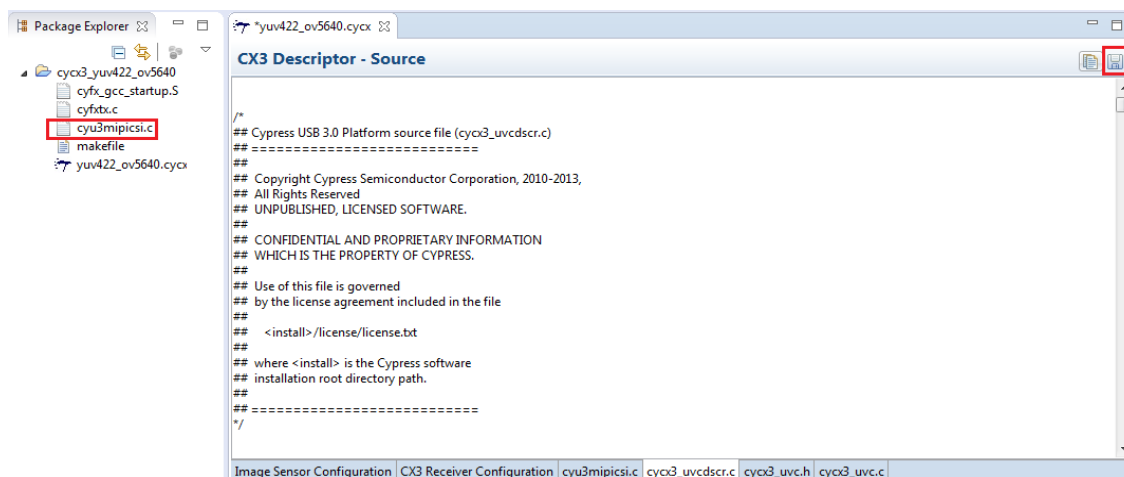

Figure 4-20: Utility generated CX3 Descriptor Source file

4.4.4.3 Adding CX3 UVC Definitions

Move to the “cycx3_uvc.h” tab to view the application definitions generated based on the streaming parameters. These definitions can be added to the related CX3 project by pressing the **Save** button located at the upper right corner of window.

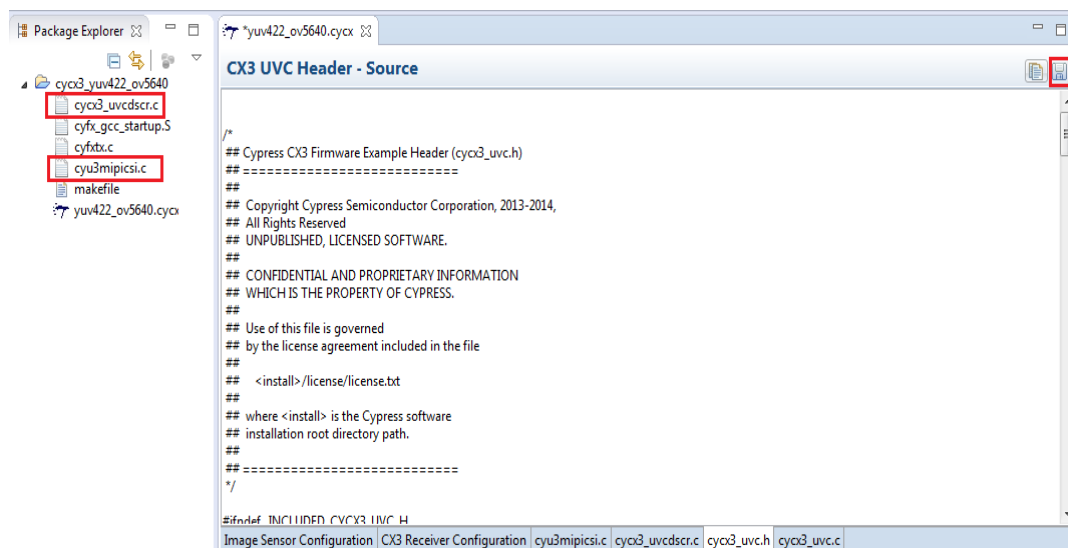

Figure 4-21: Utility generated CX3 Header file

4.4.4.4 Adding CX3 UVC application logic

Move to the “cyx3_uvc.c” tab to view the generated UVC application source code. This file can be added to the related CX3 project by pressing the **Save** button located at the upper right corner of window.

After saving to the project, the contents of this file can then be edited to add custom handling for any UVC Video Control requests.

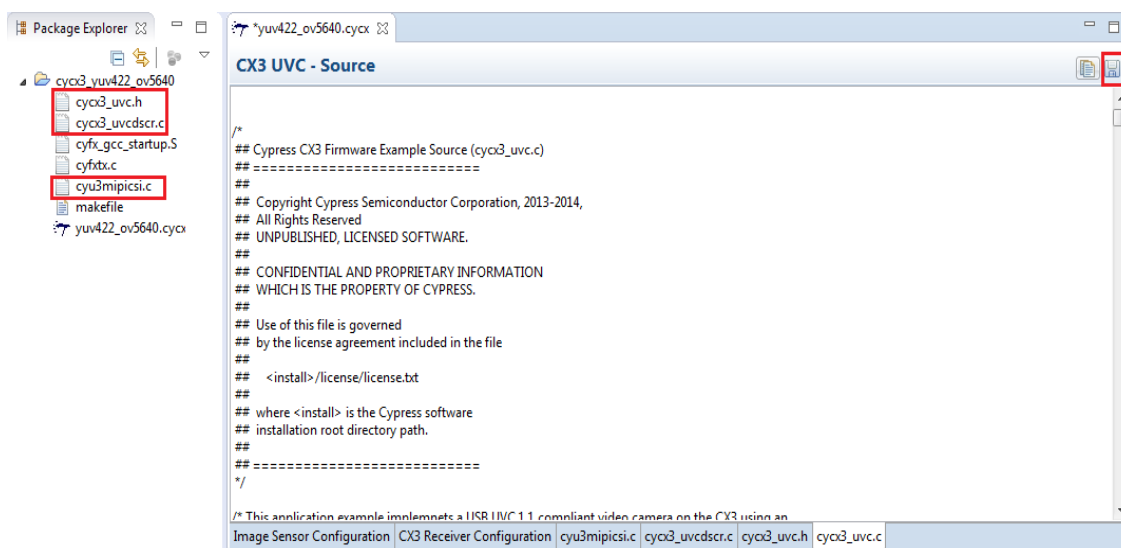

Figure 4-22: Utility generated CX3 UVC Source file

4.4.5 Locking the CX3 Project Configuration

Click the Close (X) Button to exit from the configuration utility once the project configuration is completed successfully and the code has been saved. The utility will prompt for saving any changes.

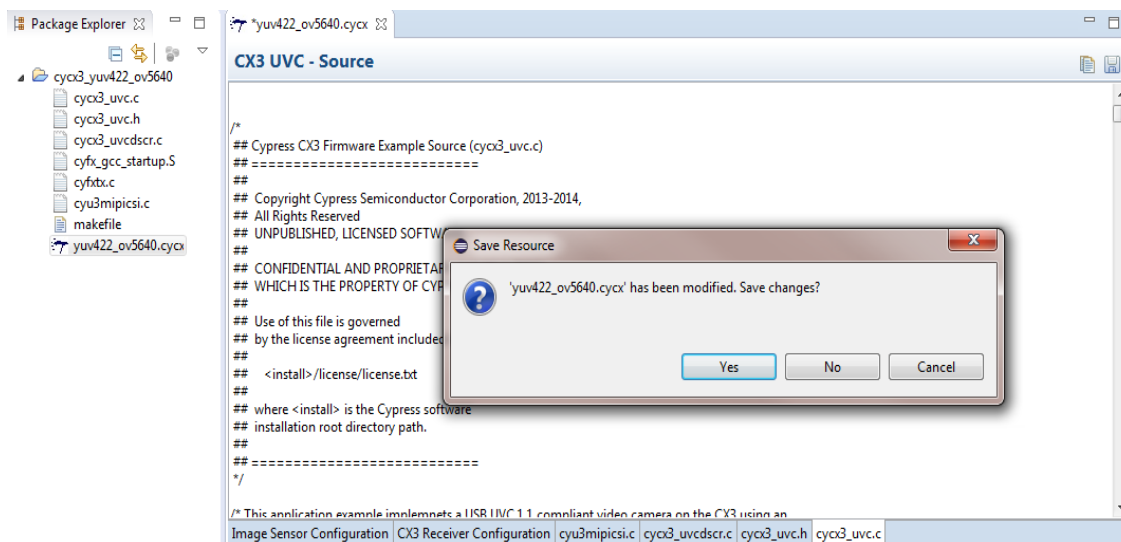

Figure 4-23: CX3 Project Configuration Lock Window

Code for the USB descriptors, sensor and CSI-2 interface configuration structures and streaming application logic would have been generated by the tool and added to the project. The project can now be compiled and used like any standard FX3/CX3 firmware project.

4.5 GPIF-II interface on the CX3

The CX3 device makes use of the GPIF-II interface to connect the DMA and USB blocks to the MIPI CSI-2 interface. Since the GPIF-II Interface connectivity is fixed, a custom GPIF-II configuration is not useful. A fixed-function GPIF-II Configuration is used by the CX3 firmware to move the data from the CSI-2 interface block to the DMA block.

4.5.1 GPIF-II Waveform

The GPIF II state machine on the CX3 implements the state machine shown in Figure 4-24. The state machine makes the parallel data provided by the MIPI CSI-2 available for transfer over two GPIF-II sockets which can be connected to a Many to One DMA channel.

The functionality of this state machine is similar to the GPIF II state machine described in Application Note [AN75779 - How to Implement an Image Sensor Interface with EZ-USB® FX3™ in a USB Video Class \(UVC\) Framework](#).

Detailed description of this state machine along with instructions on creating CX3 based application projects is provided in the Application Note [AN90369 - How to interface a MIPI CSI-2 Image Sensor with EZ-USB® CX3](#).

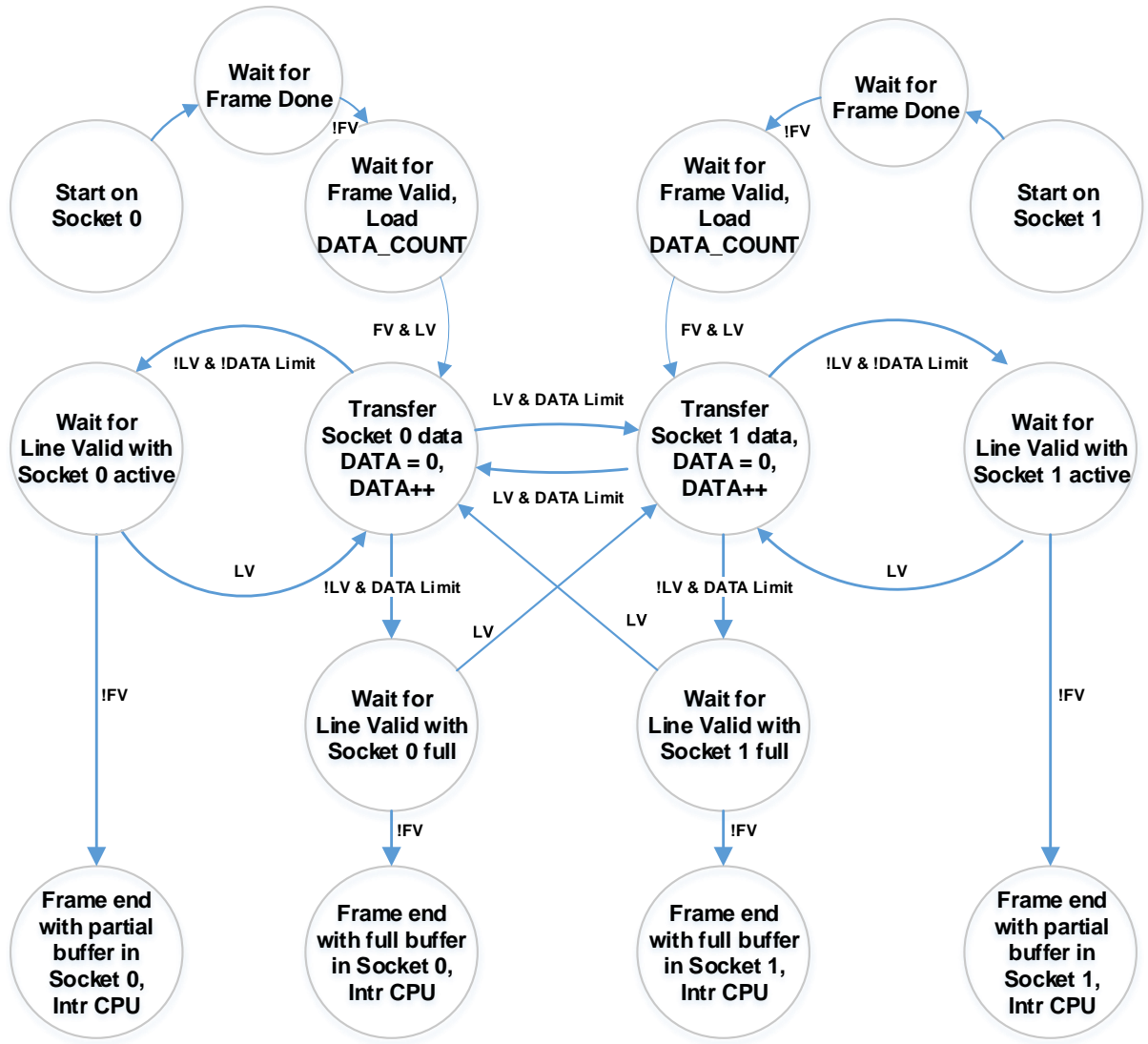

Figure 4-24: CX3 GPIFII State Machine